

SUMITOMO RECOMMENDED PROCEDURE**SRP SP-F04-041****FIELD TERMINATION KIT PROCEDURE FOR
FT48FBK 900µm SUB-UNIT KIT**

<u>PARA.</u>	<u>CONTENTS</u>
1.0	General
2.0	Safety Precautions
3.0	Reference Documents
4.0	Equipment / Tools Required
5.0	Preparing the Fiber Bundle
6.0	FT48FBK Field Termination Kit
7.0	Assembling the FT48FBK Field Termination Kit

1.0 General

1.1 This procedure describes the standard techniques for installing FutureFLEX Air-Blown Fiber (ABF) 48-fiber bundles into a FT48FBK Field Termination Kit with 900µm sub-units / colored-coded tubes.

1.2 Field Termination Kits are used at locations where fiber bundles containing 250µm fibers are to be terminated and connectorized at fiber optic patch panels, switches, or transmitter / receiver locations with splice on connectors.

2.0 Safety Precautions

2.1 The use of safety glasses is strongly recommended during this procedure.

3.0 Reference Documents

3.1 Sumitomo Recommended Procedure, *FutureFLEX Fiber Bundle Stripping Procedure*, SRP SP-F04-006.

4.0 Equipment / Tools Required

The following equipment, tools, and materials are required to complete this procedure:

4.1 FT48FBK Field Termination Kit with 900µm sub-units

4.2 Adhesive Tape

4.3 measuring tape

4.4 Appropriate clean work surface / table

4.5 cutting tool (scissors or

4.6 wire strippers (10 – 20 AWG positions)

5.0 Preparing the Fiber Bundle

5.1 Provide at least 9" – 12" of additional fiber sub unit strip-length beyond the actual fiber length required. SEL's FT48FBK Field Termination Kit has an approximate 24" buffer tube length. Therefore, the 48-fiber sub units should be stripped back at least 30" – 32".

5.2 **Important Tip.** When stripping the colored nylon from the 4 - 12 fiber sub units, the clear ripcord may not appear in the same position in every subunit. During the manufacturing process the fiber strands may move slightly changing the location of the ripcord. Be careful when pulling the ripcord and make sure it is not wrapped around any of the fiber strands.

5.3 Refer to SRP SP-F04-006 for detailed fiber bundle stripping procedures and techniques on how to remove the outer foam jacket, access sub-unit ripcords, and remove inner nylon jackets.

5.4 Once the fiber bundle has been stripped, install the 3.6mm bushing over the PEF jacket and secure it to work surface with adhesive tape.

5.5 Separate and organize fiber bundle strands and assemblies. At the point where the strands exit nylon sub-unit, carefully arrange them so they are not crossed and carefully separate them along their entire length. **See Fig. 2.**

5.5.1 48-fiber bundles contain four (4) colored nylon sub-units of 12 fibers each in the following color-order sequence:

Blue Sub-unit:

Blue, Orange, Green, Brown, Slate, White, Red, Black, Yellow, Violet, Rose and Aqua

Orange Sub-Unit:

Blue, Orange, Green, Brown, Slate, White, Red, Black, Yellow, Violet, Rose and Aqua

Green sub-Unit:

Blue, Orange, Green, Brown, Slate, White, Red, Black, Yellow, Violet, Rose and Aqua

Brown Sub-Unit:

Blue, Orange, Green, Brown, Slate, White, Red, Black, Yellow, Violet, Rose and Aqua

Note: *In the 48-fiber bundles, the clear polyester ripcord position can vary slightly in each sub-unit. It may not always appear in the same position.*

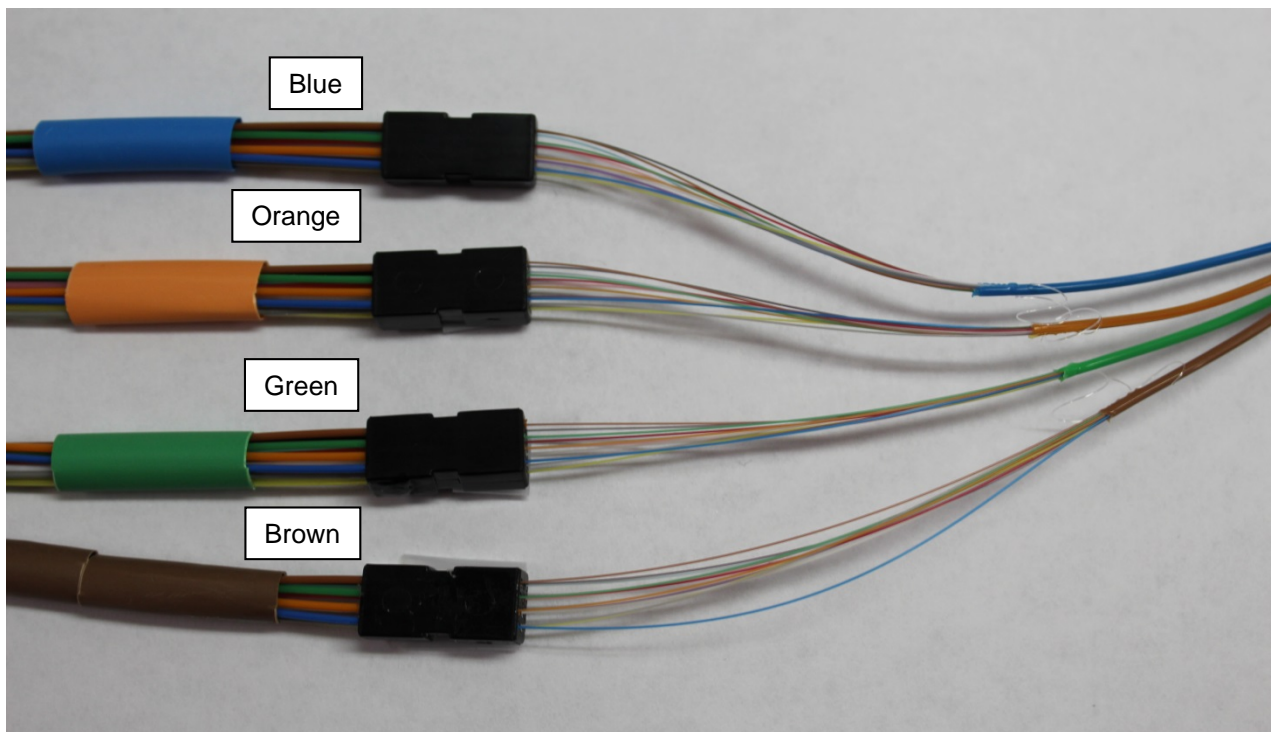

Figure 2

Organize 12-Fiber Bundle Subunits and assemblies in Color-Order Sequence

6.0 FT48FBK Field Termination Kit

6.1 FT48FBK Field Termination Kit consists of a Base Unit, Cover Unit, Four (4) Breakout Unit Assemblies, 8 colored shrink tubing pieces and a 3.6 mm bushing. **See Fig. 2 & 3.**

6.2 Base Unit cavity holds four (4) stackable Breakout Unit Assemblies.

6.3 Breakout Unit Assemblies consist of four(4) rectangular black plastic break-out blocks, each with 12 color-coded 900µm OD tubing installed

in the appropriate holes for each of the 12 colors. Fiber strands are threaded through the tubes, by color, then terminated using SEL splice on connectors. These units stack, one on top of the other, into the Base Unit cavities, 2 on each side.

6.4 The 3.6mm bushing secures the 48-fiber bundle in the Base Unit to avoid pullout.

6.5 Cover Unit snaps onto Base Unit to secure Breakout Unit Assembly and bushing and protect exposed bare fibers.

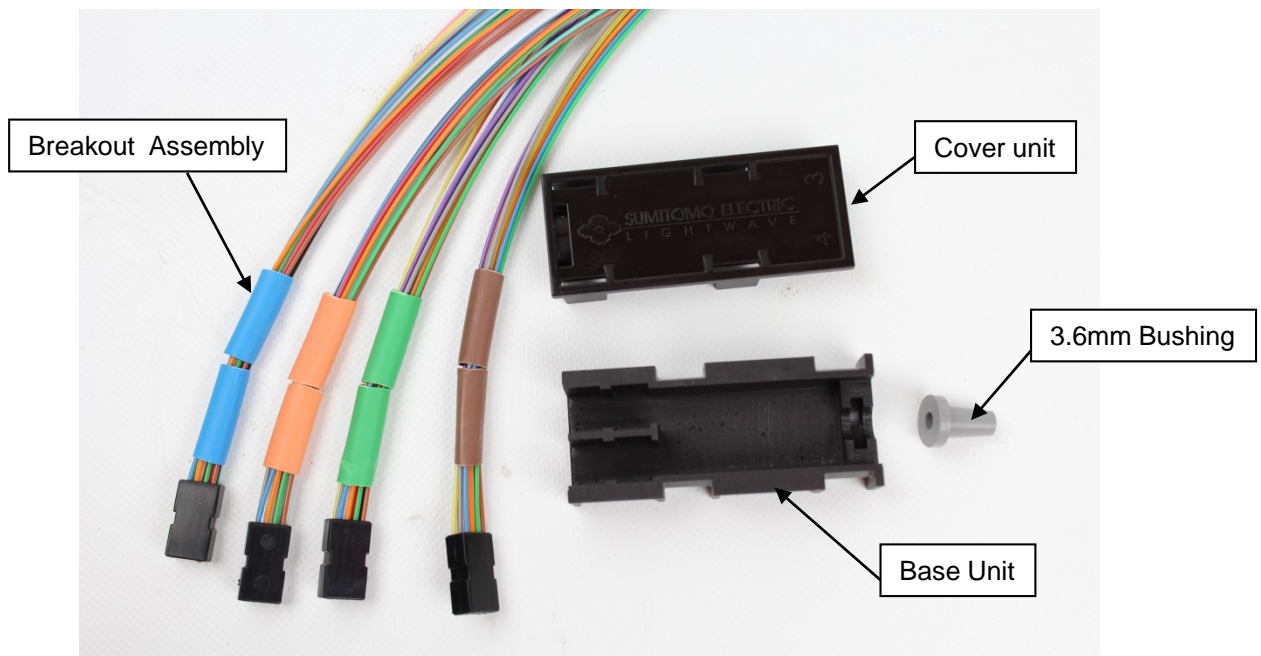

Base Unit Specifications

Dimensions (in.): 2.25" L x 1.0" W x 0.6" H
 Material: ABS Plastic
 Color: Black
 Logo: FTFLD48

Cover Unit Specifications

Dimensions (in.): 2.25" L x 1.0" W x 0.6" H
 Material: ABS Plastic
 Color: Black
 Logo: Sumitomo Electric

Tubing Specifications

Dimensions: mm / (in.):
 ID: 0.50mm +/- 0.05mm (0.020 +/- 0.002)
 OD: 0.90mm +/- 0.05mm (0.035 +/- 0.002)
 Length: Approximately 24 inches

Mechanical:

Max. Tensile Load: 45 Newtons / 10 lbs.
 Min. Bend Radius: 1.3 cm / 0.5 inch
 Crush Resistance: 52 N/cm Max. / 0.03 lbs/in
 Temp. Rating: -40°C - +85°C (-40°F - +175°F)
 Material: Thermoplastic Elastomer

Figure 3

FTFLD48 Field Termination Kit Components

6.6 Breakout Unit Assembly tube colors and arrangement matches ABF fiber bundle strand colors and arrangement. **See Fig. 4.**

Blue Sub-unit and Block

Tube	Color	Tube	Color
1	Blue	7	Red
2	Orange	8	Black
3	Green	9	Yellow
4	Brown	10	Violet
5	Slate	11	Rose
6	White	12	Aqua

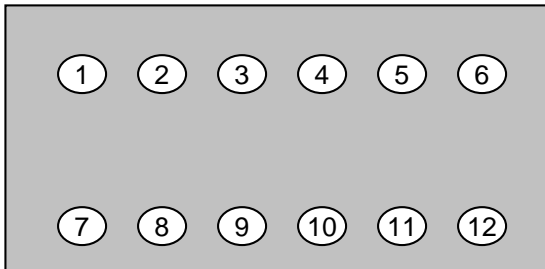

Orange Sub-unit and Block

Tube	Color	Tube	Color
1	Blue	7	Red
2	Orange	8	Black
3	Green	9	Yellow
4	Brown	10	Violet
5	Slate	11	Rose
6	White	12	Aqua

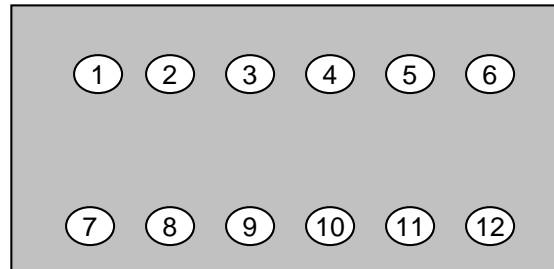

Green Sub-unit and Block

Tube	Color	Tube	Color
1	Blue	7	Red
2	Orange	8	Black
3	Green	9	Yellow
4	Brown	10	Violet
5	Slate	11	Rose
6	White	12	Aqua

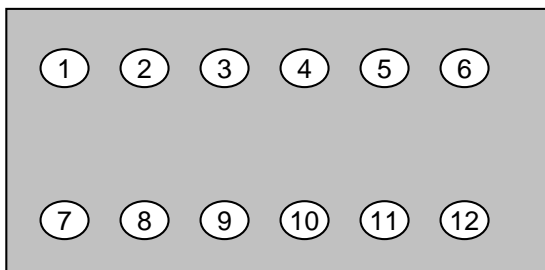

Brown Sub-unit and Block

Tube	Color	Tube	Color
1	Blue	7	Red
2	Orange	8	Black
3	Green	9	Yellow
4	Brown	10	Violet
5	Slate	11	Rose
6	White	12	Aqua

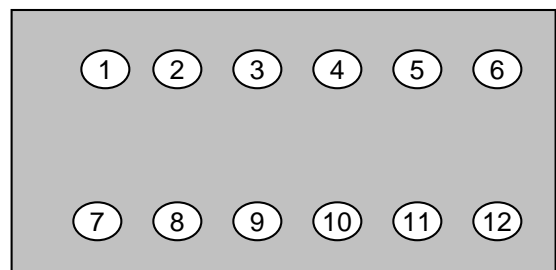

Figure 4
 Breakout Unit Assembly Tube Colors & Arrangement

7.0 Assembling the Field Termination Kit

7.1 Prepare the Blue, Orange, Green and Brown sub units and Breakout Assemblies first as in Figure 2.

7.2 Install the 3.6mm bushing onto the end of the stripped back PEF jacket.

7.3 Begin with the Blue sub-unit. Insert each fiber into its colored-coded tube. Begin with the blue strand first, followed by the orange, and so on until all 12 fibers are started into the Breakout Unit Assembly 900 μ m tubes. Work carefully, comb the fibers, and ensure strands are not crossed or twisted. **See Fig. 5.**

7.4 Repeat the process with the Orange, Green and Brown Sub-Units.

7.5 Once all the strands of the four sub-units are inserted into the tubing, carefully grasp and push all fibers through each Breakout Unit Assembly tubing as a group.

7.6 Install the Blue subunit in position # 1 and Orange into position 2 of the base unit. Looking from the bushing location, the Blue assembly goes in the bottom left cavity and Orange assembly goes into the bottom right cavity. (**see Fig. 7**)

7.7 Install the Green subunit into position 3, directly on top of the Blue subunit, and the Brown into position 4 of the base unit directly on top of the Orange subunit. The Green subunit goes in the top left cavity and the Brown assembly goes in the top right cavity (the actual placement of the assemblies is not critical). It is important to be able to distinguish each sub unit. We have provided 8 colored (BL, OR, GR & BRN.) shrink tubes, two of each color, to insert over the corresponding colored sub unit's at each end of the 900 μ m tubes for easy identification.)

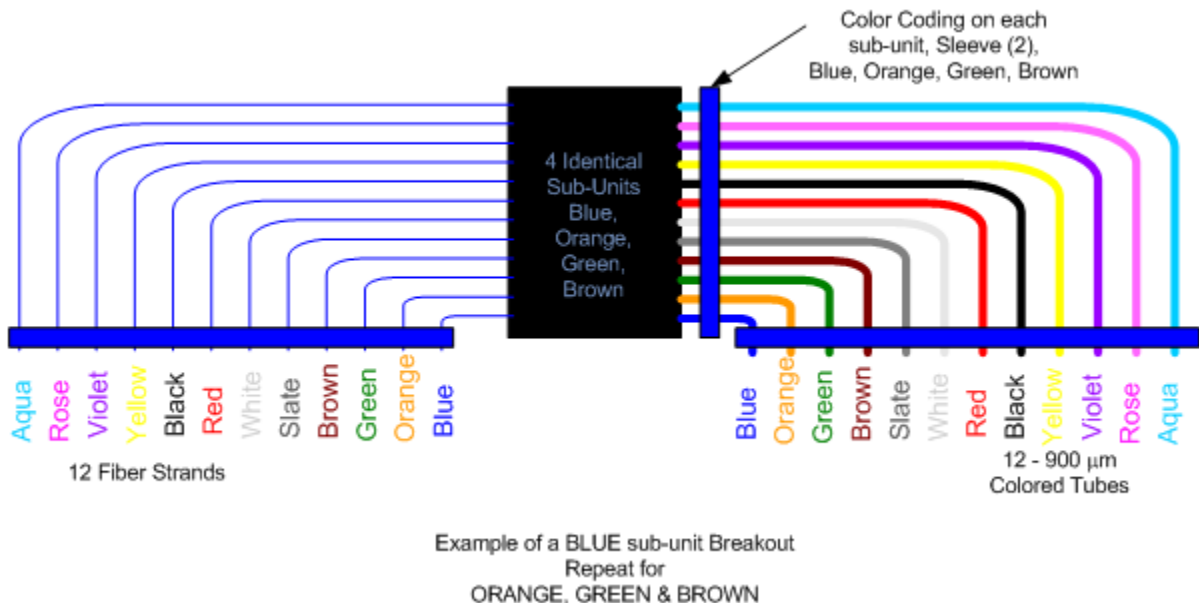

Figure 5

Fiber Strands in Color-Order Ready to be Inserted into Breakout Unit Block, One at a time then Pushed through tubes as a group.

Figure 6

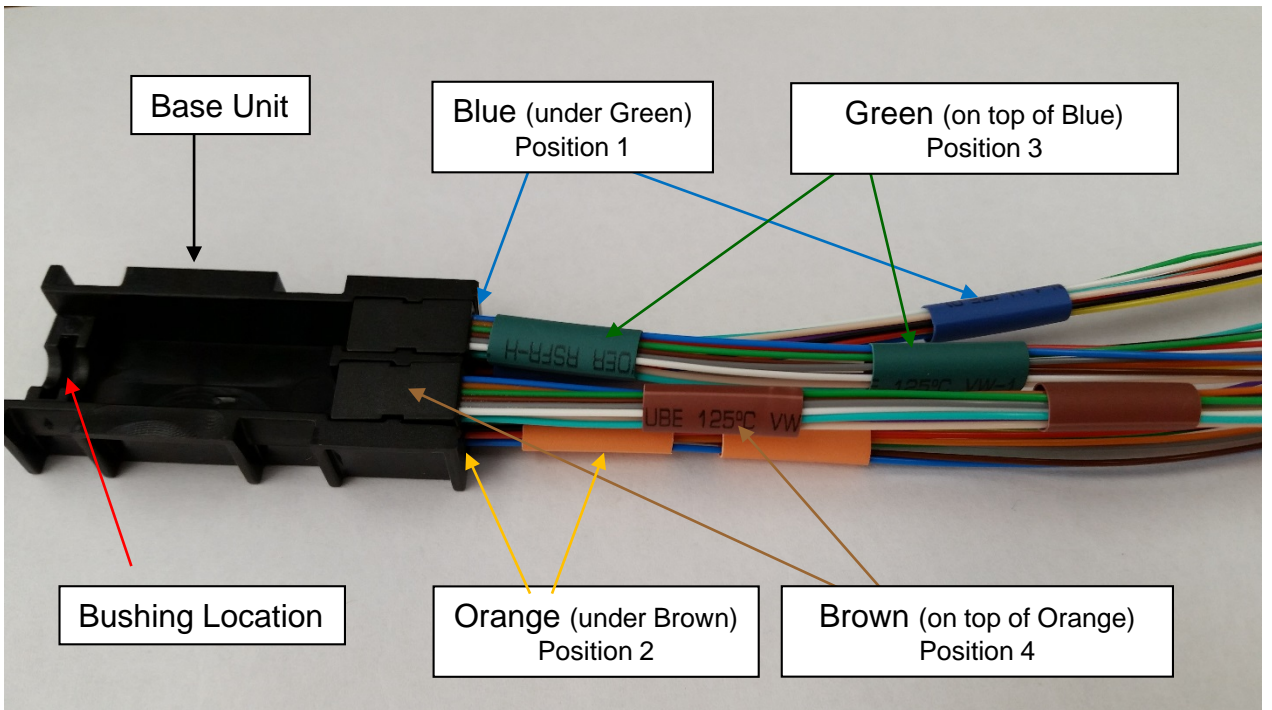
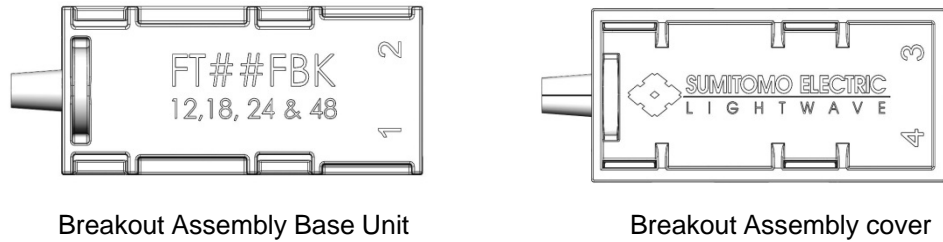

Figure 7

48 Fiber Breakout Kit fully assembled except for the cover unit

7.8 Once all fibers are inserted into Breakout Unit Assemblies re-confirm that fiber strands are not crossed or twisted over each other between the end of the nylon jackets and the Breakout Unit Assembly block. Crossed fibers may cause additional optical attenuation due to macro-bending. (Our new units are longer than our previous units to allow more length between the PEF jacket and the assembly blocks which makes it less likely to cause attenuation issues.) If fibers are crossed, they should be carefully removed from the Breakout Unit Assembly tubes, straightened out, and re-installed. **See FIG. 8**

7.9 Carefully place the Breakout Unit Assemblies into the Base Unit cavity. (Blue, Orange Green and Brown) to maintain correct color-order sequence. **See Fig. 6.**

7.10 Carefully push all the fibers as a group into Breakout Unit Assemblies until ends of the PEF jacket and inner nylon jackets are even with or just past the inside of the 3.6mm bushing.

7.11 Slide the 8 colored heat Shrink Tubing pieces into position over the corresponding sub Units at each end.

7.12 Complete the FT48FBK Field Termination Kit assembly by snapping Cover Unit onto Base Unit. **see FIG. 7**

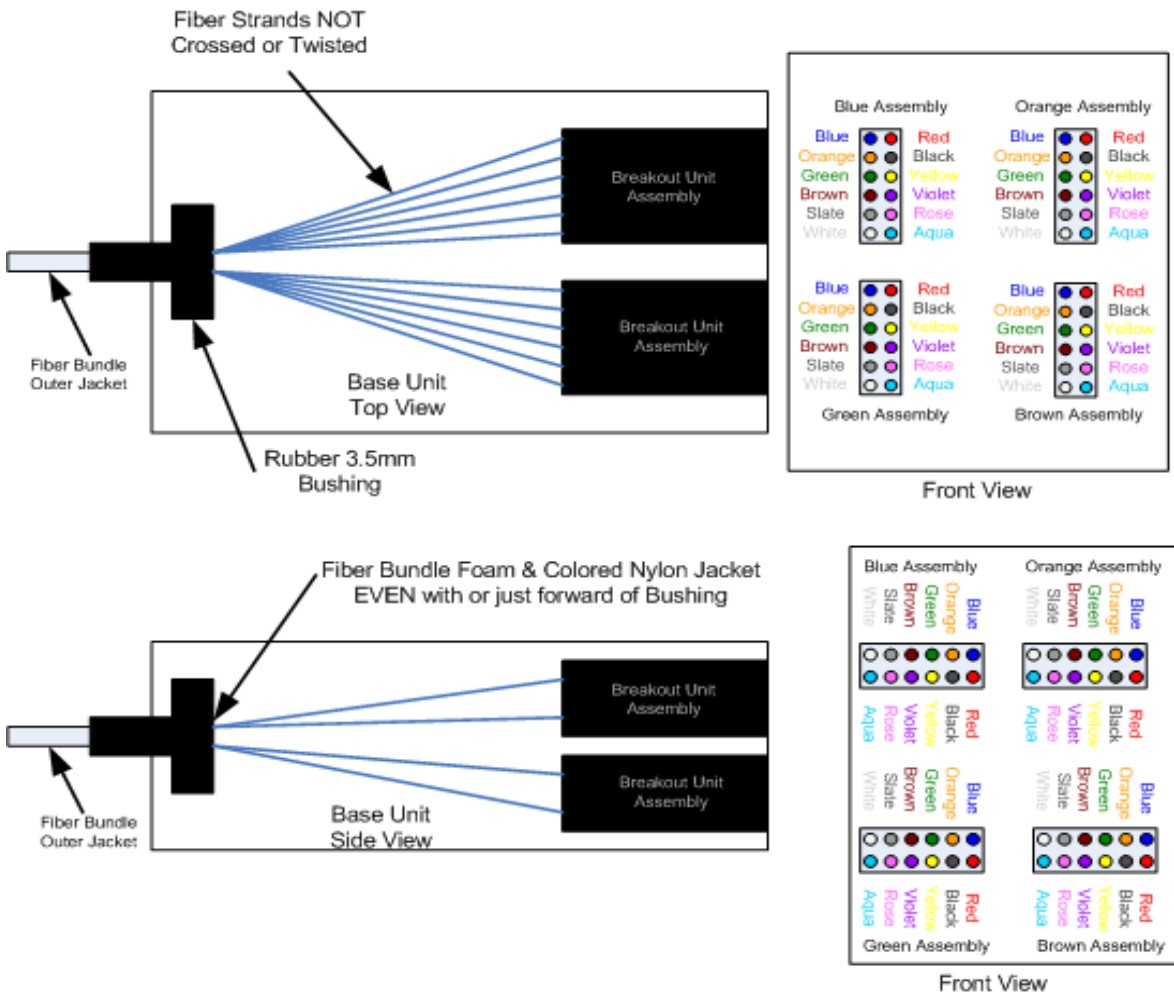

Figure 8
Fiber Bundle Foam & Nylon Jackets
Even With or Just Forward of 3.6mm bushing