

SET

OME0524018

Direct Core Monitoring Optical Fiber Fusion Splicer

“MicroCore[®]”

TYPE-39

Guide to operation

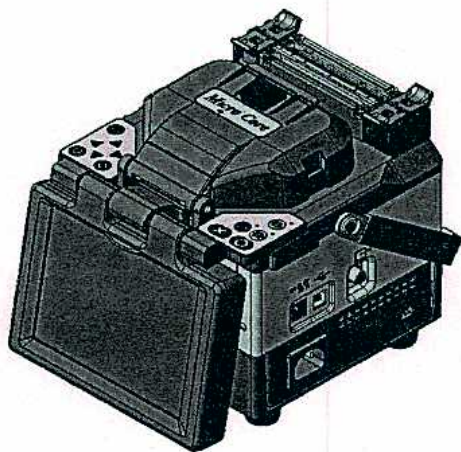

SUMITOMO ELECTRIC
Ingenious Dynamics

=IMPORTANT SAFETY PRECAUTIONS=

This product has been designed and manufactured to assure personal safety. Improper use can result in fire, electric shock or injury to persons. Read and observe all warnings instructions given in this operation manual. Use your splicer only for its intended purpose.

Caution

1. All rights are reserved. No parts of this manual may be photocopied, reproduced or translated to another language without the prior written consent of Sumitomo Electric Industries, Ltd.
2. Information in this manual is subject to change without notice.

-The meaning of these symbols-

In this operation manual, symbols are used to highlight warnings and cautions for you to read so that accidents can be prevented. The meanings of these symbols are as follows:



This symbol indicates explanations about extremely dangerous matters. If users ignore this symbol and handle the splicer the wrong way, serious injury such as fire or electric shock, or death could result.



This symbol indicates explanations about dangerous matters. If users ignore this symbol and handle the splicer the wrong way, bodily injury and damage to the equipment could result.



Be sure to read the following warnings before operating.

1. Always observe the connection method defined in this manual. Failure to do so may cause a fire or electric shock.
2. Do not use a voltage other than the indicated power voltage. Doing so may cause a fire or electric shock.
3. To reduce the risk of fire, electric shock or malfunction, do not get liquid such as water or a metallic object inside the splicer. Check for condensation before using. If necessary, dry the splicer with a hair dryer before operation.
4. Do not make mechanical or electrical modifications to the splicer since this may expose you to dangerous voltage or other hazards.
5. If water or other liquid, a metallic object or foreign substance gets inside the splicer, immediately turn off the power and disconnect the power plug. Contact our maintenance service center.
6. If an abnormal condition such as unusual noise, smoke or unusual odor occurs, immediately turn off the power and disconnect the power plug. Next, contact our

maintenance service center.

7. Do not use the AC power supply module and the battery module for the machines other than the specified splicer. Doing so could damage the modules, causing heat or fire to occur.
8. Do not allow the splicer to be exposed to rain or sea water. Doing so can cause electric shock by shorting out interior components.
9. This fusion splicer performs an arc discharge. Avoid the use of the splicer in a hazardous location in which inflammable gas can generate or only electrical apparatus for explosive gas atmosphere can be used.
10. Do not touch the electrodes. Doing so may cause personal injury or electric shock.
11. Do not let water or sea water wet or soak the battery. Safety and protective devices to prevent danger are built in the battery. If these devices are damaged, excessive current flow may cause abnormal chemical reaction in battery fluid, heat generation, bursting and fire.
12. Do not use or leave the battery under high temperature conditions such as near fire.
13. Only use a specified battery charger. Failure to do so can cause the battery to be overcharged or excessive current flow may cause abnormal chemical reaction in battery fluid, heat generation, bursting and fire.
14. Make sure the polarities are correctly connected. Do not attempt to connect the battery or other equipment when you cannot do. Reversed connections may cause abnormal chemical reaction in battery fluid, heat generation, bursting and fire.
15. Use the battery only for the application for which it was designed. Failure to do so will result in a loss of performance and a shortened life expectancy. Also excessive current flow may cause loss of control during charging or discharging of the battery, heat generation, bursting and fire.
16. Before using the battery, observe the following tips.
 - Do not burn the battery or throw it into a fire. Doing so may cause heat generation, bursting and fire.
 - Changing with polarity reversed can cause a reversal in battery polarity resulting in abnormal chemical reaction, heat generation, bursting or fire.
 - Do not directly connect the positive and negative terminals with a conductive material such as a wire. Do not carry or store the battery together with any personal jewelry, hairpins or other metallic objects. Metallic objects can cause an electrical short circuit. Also excessive current flow may cause abnormal chemical reaction in battery, heat generation, bursting and fire.
 - Do not throw or impact the battery. Safety and protective devices to prevent danger are built in the battery. If these devices are damaged, excessive current flow may cause abnormal chemical reaction in battery fluid, heat generation, bursting and fire.
 - Do not pierce the battery with nails, strike the battery with a hammer, or step on the battery. Doing so will cause internal short circuit, heat generation, bursting and fire.
 - Do not solder any lead wires directly to the battery.
 - Do not place the battery in microwave ovens, high-pressure containers.

- Avoid mixed usage of the batteries differing in capacity, type, and manufacturer.
- 17. Do not disassemble or modify the battery. Safety and protective devices to prevent danger are built in the battery. If these devices are damaged, excessive current flow may cause loss of control during charging or discharging of the battery, heat generation, bursting and fire.
- 18. In the event the battery leaks and the fluid gets into one's eyes, do not rub the eyes. Immediately wash them thoroughly with clean water enough from the tap and consult a doctor urgently.
- 19. Unplug the fusion splicer before attempting any electrical maintenance. Avoid contact with the high-voltage electrodes used to produce the arc.
- 20. Do not use compressed gas (i.e., canned air) to clean the splicer. Poor splice performance may result.



Be sure to read the following cautions before operating.

1. Avoid places with too much dust or dirt. Dirt or dust that can accumulate in the splicer causes short circuit and insufficient cooling, which may result in fire or electric shock due to the splicer malfunction or deterioration.
2. Always use and store the splicer in the locations defined in a brochure and this manual. Failure to do so may cause splicer malfunction or deterioration, resulting in fire or electric shock.
3. Disconnect the power cord by grasping the plug, not the power cord.
4. Wear safety glasses at all times for protection from glass fibers.
5. Only use alcohol to clean the splicer. To prevent malfunction and damage, do not use any other kind of chemicals.
6. In a high location, fix the splicer to a tripod with the M8 screw or inch screw on the bottom of the splicer.
7. Do not operate the splicer in rain. Doing so may cause AC power supply module or batter module to be short-circuited.
8. Do not expose the splicer to extremely high temperature and high humidity or to direct sunlight for prolonged periods.
9. Always turn off the power to the splicer after use. Failure to do so can cause the battery to be overcharged and deteriorated in performance.
10. If you are not going to use the splicer for a while, remove the battery before storing it. Failure to do so will shorten a battery life.
11. The TYPE-39 is a precision instrument. When transporting the splicer, use its specified transport case to protect it from dust, dirt, moisture, shock and impact.
12. The heating plate of the heat shrink oven may be hot during and after heating. Do not touch it directly.

IMPORTANT: TYPE-39 SOFTWARE USER LICENSE

Copyright © 2006 SUMITOMO ELECTRIC INDUSTRIES, LTD. All rights reserved.

ATTENTION: The software installed in the TYPE-39 SPLICER ("this software") is the property of SUMITOMO ELECTRIC INDUSTRIES, LTD. The usage of this software is granted by a license. CAREFULLY READ AND THIS LICENSE BEFORE USING THIS PRODUCT.

The copyright and all other rights to this software, its documentation and the writings concerning this software ("the writings"), which contain CD-ROM, operation manual, guiding document, data tables, command lists, writing information (photos, images, drawing, text) on appended other printed materials, shall remain with SUMITOMO ELECTRIC INDUSTRIES, LTD. By commencing the use of this software, you acknowledge that you have read the following license and indicate that you agree to its terms. In case of disagreement, contact SUMITOMO ELECTRIC INDUSTRIES, LTD. or our product supplier.

LICENSE AGREEMENT

This license is the entire agreement between SUMITOMO ELECTRIC INDUSTRIES, LTD. and you.

1. LICENSE

The following restricted rights are granted. YOU MAY:

- a) use on a splicer in which this software is installed.
- b) create or distribute a construction manual based on the writings on condition that you clarify their source.
- c) create an execution report of construction based on displayed information, and the writings.
- d) create a document (manual or execution report) concerning the maintenance of the splicer in which this software is installed or control its splice-quality upon displayed information and the writings.
- e) make one copy of the writings for archival or backup purpose.

2. RESTRICTIONS

The following act is forbidden on this license, except our prior written consent. YOU MAY NOT:

- 1) sell, distribute, rent, lease, transfer, or disclose the whole of the writings to the public or unidentified parties and transfer, disclose or display the electrical formal of the writings through online media.
- 2) make copy of the writings except as permitted in this license.
- 3) reverse engineer, decompile, disassemble this software and analyze, modify or merge the program.

3. CONTRACTING PARTIES

If you rent, lease, transfer, or resell the splicer, in which this software is installed, to a corporation or other entity, then this agreement is formed by and between SUMITOMO ELECTRIC INDUSTRIES, LTD. and such entity. You shall be liable for such entity to agree to the same all conditions of this license.

4. TERM AND TERMINATION

This agreement shall continue in effect until terminated. You may terminate the agreement at anytime by stopping the use of the splicer in which this software is installed. If you fail to comply with any of the provision of this license, your license will be automatically terminated. Upon termination, you shall transfer the writings to the owner of splicer (In the case that you transfer the splicer to other corporation or entity) or return them to us, otherwise erase or destroy them by appropriate means. You shall forever hold in confidence all trade secrets brought by this license. Further you agree not to disclose to any third party.

5. LIMITATION OF LIABILITY

SUMITOMO ELECTRIC INDUSTRIES, LTD. and our supplier shall not be liable for consequential, incidental or accidental damages in connection with this software or this agreement and whether this software shall meet your special requirements, special efforts or special method beyond the range described in the operation manual concerning this software.

6. GENERAL

If any provision of this agreement is declared by the court of competent jurisdiction to be invalid, illegal, or unenforceable, such provision shall be severed from the agreement and the other provisions shall remain in full force and effect.

ACKNOWLEDGEMENT

The Company name and brand or product names of the optical fiber on database in this software are trademark or registered trademark of their respective companies. Please acknowledge that it is not possible to spread complete names on some cases because of the limitation of letter length capacity.

MicroCore[®] is a trademark of SUMITOMO ELECTRIC INDUSTRIES, LTD.

MicroCore: Applicable patents of TYPE-39

U.S. Patent

5,777,867

CANADA Patent

2,183,840

Table of contents

IMPORTANT SAFETY PRECAUTIONS

IMPORTANT: TYPE-39 SOFTWARE USER LICENSE

1. General	1
Product overview	1
Optical fiber requirement	1
Features overview	1
Standard equipment	2
Tools (Jacket remover, Fiber cleaver)	3
Optical accessories	3
Consumables	3
Structure	5
Fusion splicer	5
Keypad	6
V-grooves, electrodes, other components	7
Heat shrink oven	8
Input/output panel	8
2. Splicing / protection	9
Preparing power supply	10
AC operation	10
Battery operation	11
Battery level check	12
Battery charging	13
DC operation	14
Battery refreshing	14
Precautions for battery module	14
Operating procedures	16
Turning on the TYPE-39	16
Initial screen	16
Fiber type and protection sleeve settings	17
Stripping the fiber coating / Cleaning the bare fiber	18
Cleaving the fiber	19
Inserting the fibers into the splicer	21
Arc test procedure	22
Fiber preparation	24
Starting the automatic splice	25
Positioning the splice in the heat shrink oven	28
Maintenance	30
Names of components	30
Cleaning V-grooves	31
Cleaning LEDs and mirrors	31
Cleaning bare fiber pads	32
Cleaning microscopes	32
Cleaning heat shrink oven	33

Replacing electrodes	34
Packing and storage instructions	34
3. Functions	38
Adjusting the settings	38
Function settings	41
Maintenance settings	43
4. Other functions	44
Back monitor type	44
Detachable/attachable bare fiber pads	44
Dual heat shrink oven	45
Auto start	45
Splice data storage function	46
Tripod fixing screws	47
5. Troubleshooting	48
Arc problems	48
Fiber breaking	48
Splicer does not power up	48
Warranty and repair service	49
Error message list	50
Product specifications	53

Optical fiber equipment

The TFS-30 can splice the following optical fiber types:

Optical Fiber Type	Core Diameter (mm)	Cladding Diameter (mm)	Core Diameter (mm)	Cladding Diameter (mm)
Plastic Optical Fiber	0.5-1.0	1.0-2.0	0.5-1.0	1.0-2.0
Dispersion-shifted Fiber	8-10	125	8-10	125
Bend-insensitive Fiber	8-10	125	8-10	125
Bend-insensitive Fiber (with Core Cladding)	8-10	125	8-10	125
Dispersion-shifted Fiber	8-10	125	8-10	125
Dispersion-shifted Fiber	8-10	125	8-10	125
Dispersion-shifted Fiber	8-10	125	8-10	125
Dispersion-shifted Fiber	8-10	125	8-10	125
Dispersion-shifted Fiber	8-10	125	8-10	125
Dispersion-shifted Fiber	8-10	125	8-10	125

* The maximum length of the fiber to be spliced is 100m.

Feature overview

THE TYPE 30 (A) features are:

- Dual heat shrink oven (for more information, see page 45).
- Heat shrink ovens are equipped with the latest rollers for the first time in the industry.
- The ovens are fully and quickly operation can be improved and efficiency.

1. General

Thank you very much for purchasing the TYPE-39 MicroCore Fusion Splicer (hereinafter called "the TYPE-39").

The TYPE-39 automatically pre-inspects and aligns a pair of optical single fibers with equipped microscopes, and then fuses them together with heat from an electric arc to form a low-loss splice. A protection sleeve is applied over the bare glass and cured in the built-in heat shrink oven.

Before using the TYPE-39, read all instructions completely.



Read this manual carefully in its entirety to fully understand machine capabilities. Save this manual in a location in which you can easily get to see.

Product overview

Optical fiber requirement

The TYPE-39 can splice the following optical fiber types.

Material	Silica grass
Profile type	SMF, MMF, DSF, NZ-DSF
Fiber diameter	80 - 150 μ m *1
Fiber coating diameter	100 - 1,000 μ m
Fiber count	Single fiber
Cleave length	8 - 16mm (250 μ m Coated fiber) 10mm (except for 250 μ m Coated fiber)

*1 Fiber diameters, except 125 μ m, are applicable only for splicing in room temperature

Features overview

The TYPE-39 key features are:

• **Dual heat shrink oven** (For more information, see page 44.)

2 heat shrink ovens are equipped with the fusion splicer for the first time in the industry.*

The ovens run individually and splicing operation can be improved more effectively.

*as of March, 2006

• **Auto start** (For more information, see page 45.)

In addition to the function that automatically starts the splicing process when the hood is closed, the world's first function that automatically starts the heating cycle when fiber is placed into the heat shrink oven is provided.* These functions enable performing fusion splice and heat shrink protection without keypad operation.

*as of March, 2006

Standard equipment

Check to make sure that the following items have been included.

Standard equipment

No.	Description	Part number	Quantity
1	Fusion splicer TYPE-39	TYPE-39	1 pc
2	Power supply module (Battery charger)	PS-66	1 pc
3	Power cord	-	1 pc
4	Cooling tray	-	1 pc
5	Battery charge cord	BCC-65	1 pc
6	Spare electrodes	ER-10	1 pair
7	Operation manual	-	1 pc
8	Quick reference guide	-	1 pc
9	Carrying case	-	1 pc

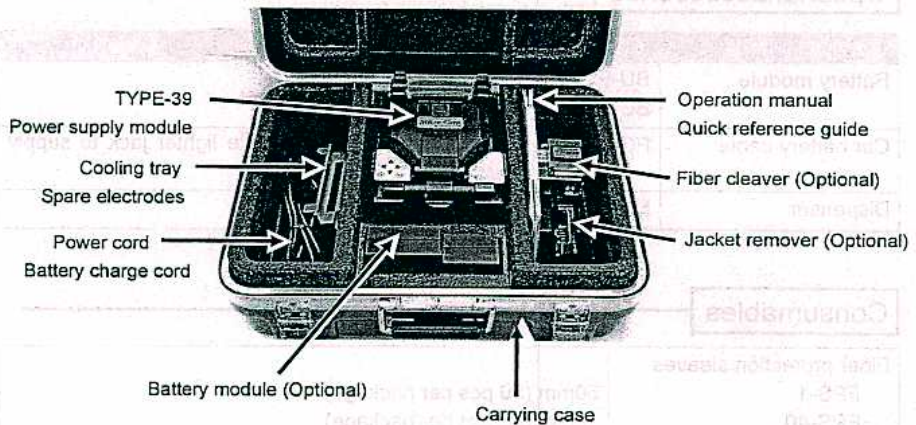

Tools (Jacket remover, Fiber cleaver)

Description	Part No.	Remarks
Precision fiber cleaver	FC-6S FCP-22	Applicable coating diameter: 250 - 900 μ m Applicable fiber diameter: 125 μ m Replacement blade for cleaver: FCP-20BL
Jacket remover	JR-25	Applicable coating diameter: 250 μ m, 900 μ m Applicable fiber diameter: 125 μ m Replacement blade for remover: JR-25BL

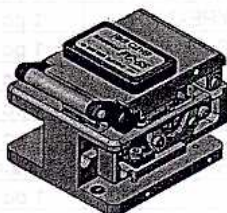

[FC-6S]

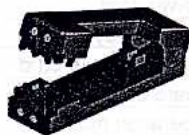

[JR-25]

Optional accessories

Description	Part No.	Remarks
Battery module	BU-66S BU-66L	Nominal capacity: 4500mAh Nominal capacity: 9000mAh
Car battery cable	PC-V66	Plugged into a car's cigarette lighter jack to supply electric power to splicer
Dispenser	HR-3	Dispenser for alcohol

Consumables

Fiber protection sleeves		
FPS-1		60mm (50 pcs per package)
FPS-40		40mm (25 pcs per package)
FPS-S-60		60mm (50 pcs per package) thin sleeve
FPS-S-40		40mm (50 pcs per package) thin sleeve
Battery module Electrodes		Battery modules and electrodes are considered a consumable that degrades with time and usage and is replaceable by a customer. Therefore they will not be covered under warranty.

Monitor	Monitors are considered a component that degrades and is deteriorated with time and usage. Sumitomo maintenance service center should replace the monitors and the parts cost for replacement is charged. They might not be covered under warranty.
---------	---

•Regarding standard equipment, consumables, or optional accessories, please order the new item you need with the item description and part number to our sales personnel.

•For repair, contact our maintenance service center.

<Availability of spare parts>

The availability of spare parts for the splicer must be guaranteed for a period of 7 years from the date production ends.

Fusion splicer

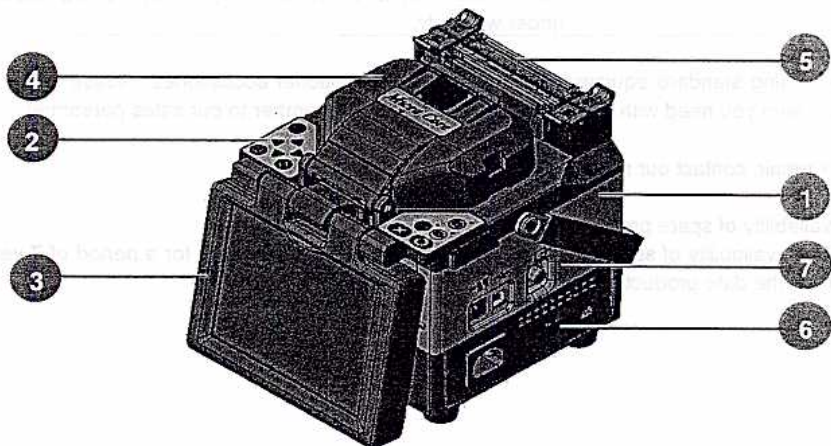

1 Main body -TYPE-39

2 Keypad

Keys are used to turn on the power, perform a splice and heat shrink protection, and setup functions.

3 Monitor

Displays fiber image, splice data and menu screen.

4 Hood

Provides protection from the environment.

5 Heat shrink oven

Used to shrink fiber protection sleeves. 2 heat shrink ovens (front and rear) are equipped.

6 Power module bay

Power supply or battery module is installed.

7 I/O panel

DC output terminal for heated jacket remover and USB port

Keypad

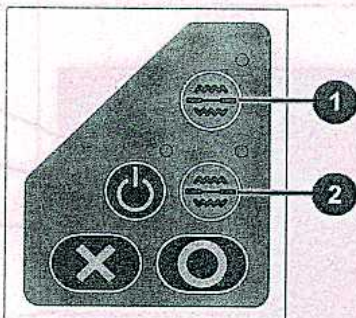
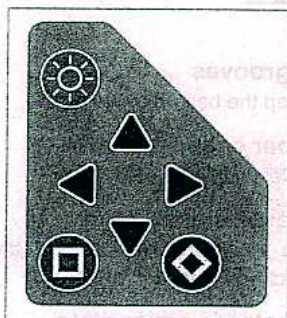

Brightness control key
Adjusts brightness of monitor.



Up arrow key
Used to move cursor and enter numeric values.



Left arrow key
Used to move cursor, enter numeric values and go back to the previous screen.



Down arrow key
Used to move cursor and enter numeric values.



Right arrow key
Used to move cursor, enter numeric values and select items.



Square key
Used to access the menu screen and for manual re-arcng of a completed splice.



Diamond key
Used to display key guidance.



Power key / LED
Used to turn on and off the splicer. LED illuminates while the splicer is on.



SET key
Starts a splicing operation.



RESET key
Used to abort a splicing operation and initialization.



HEAT key [1] / LED
Starts the rear heat shrink oven. LED illuminates during the heat cycle.

HEAT key [2] / LED
Starts the front heat shrink oven. LED illuminates during the heat cycle.

V-grooves, electrodes, other components

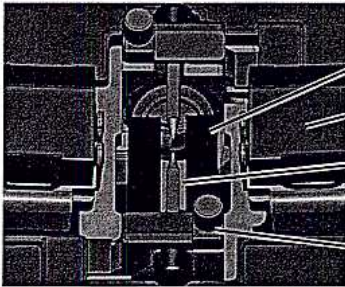

- 1 V-grooves**
Keep the bare fibers aligned.
- 2 Fiber coating clamp**
Holds the fiber coating.
- 3 Electrodes**
Arc is generated between the electrodes.
- 4 Electrode cover plate**
Holds the electrode seated into the retaining groove.

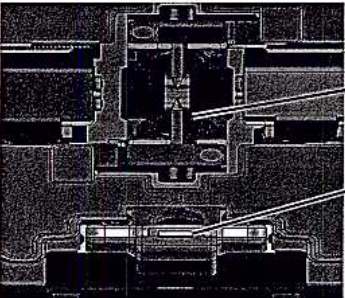

- 5 Microscope lens**
Fiber is observed with the lens.
- 6 V-groove illumination**
Illuminates the V-groove. Lit when the hood is opened.

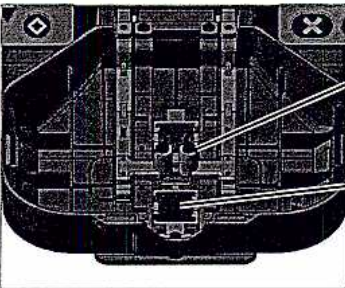

- 7 Bare fiber pads**
Hold fibers seated into the V-grooves. Attached to the hood.
- 8 Mirror**
Reflects the illumination for a microscope.

Heat shrink oven

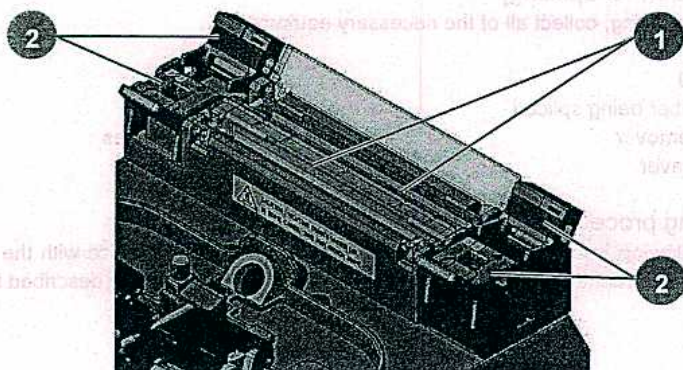

- 1 Heating plate**
Heats fiber protection sleeve.

- 2 Heat shrink oven clamps**
Hold the fiber straight.

Input/output panel

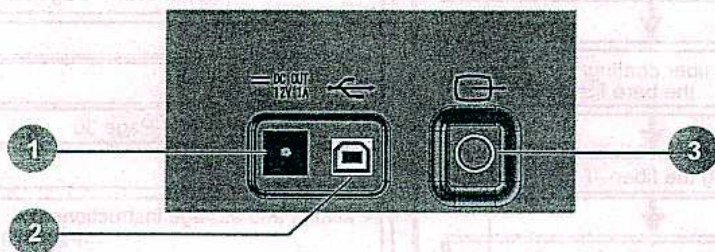

- 1 DC output terminal**
Used to supply DC power to heated jacket remover.

- 2 USB port**
Used to download stored splice loss data when connected to a PC.

- 3 Video output terminal**
Used for external monitoring.

2. Splice / Protection

[Preparation for splicing]

Before splicing, collect all of the necessary equipment.

- TYPE-39
- Optical fiber being spliced
- Jacket remover
- Fiber cleaver
- Pure (99%) alcohol
- Lint-free gauze wipes
- Fiber protection sleeves

[Operating procedures]

The following is a summary of the steps required to make a splice with the fusion splicer. For further information on each step, please see the page described below.

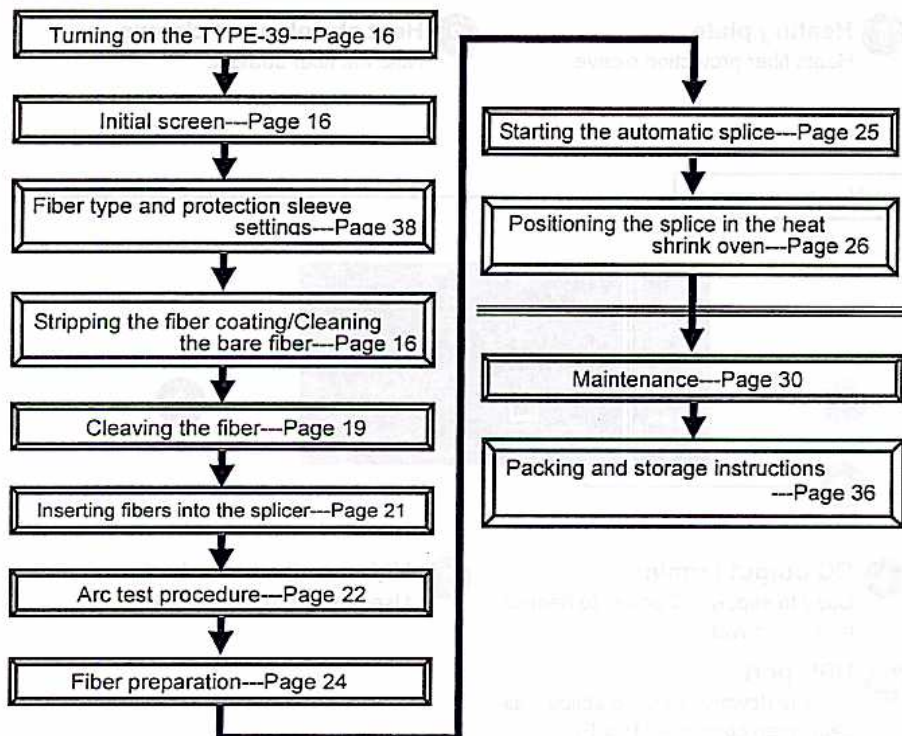

Preparing power supply

The TYPE-39 operates on AC power supply module, DC power supply module, or a battery module.

AC operation

Insert the AC power supply module (PS-66) into the module bay.

Installation

Insert the AC power module (PS-66) into the module bay and slide forward until it locks into space.

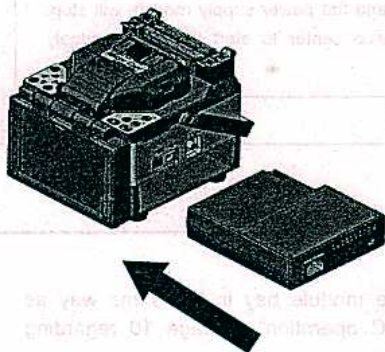

Removal

<1> While pressing the release button located on the rear of the splicer, <2> slide the module out of the module bay until it is free from the splicer.



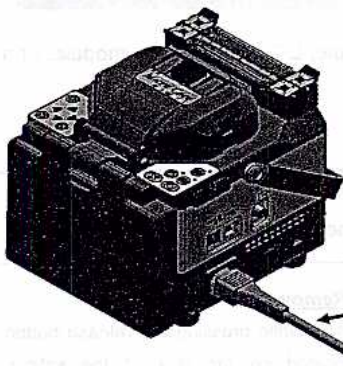

Plugging

Insert the power cord into the power supply module completely. POWER LED lights up green when the AC power is supplied.

AC power cord



If excessive current flows in the power supply module, a safety and protective device to prevent danger is activated and the power supply module will stop. Please contact our maintenance service center to start the power supply module back up.

Battery operation

Insert the battery module (BU-66S/L) into the module bay in the same way as inserting the power supply module. (See "AC operation" at page 10 regarding installation and removal of the battery module.)

Before inserting the battery module, ensure that the battery is charged enough. (See "Battery level check" at page 12.)

[Reference]

The splice cycles per fully charged battery module (BU-66S) is **100 cycles**. (Condition: Using a new battery module, 1 splice cycle shall be completed in 90 seconds in room temperature, without using a heated jacket remover.)

Battery level check

Press the battery check button. The LED will light up for a few seconds to indicate the battery status in one of four levels.

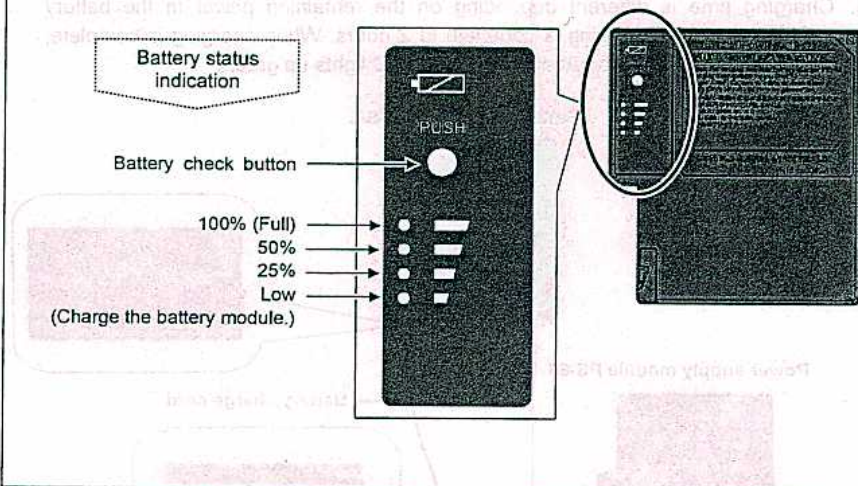

Indicator	Battery level
	Full
	Half
	Low
	No usable

The battery level is also displayed by the battery level indicator on the monitor.

Be sure to charge the battery before use when the battery level is low.

The battery level is not displayed on AC operation.

Battery charging

1. Connect the power cord to the power supply module. The POWER LED of the power supply module lights up green.
2. Connect the battery charge cord between the power supply module and the battery module. The CHARGE LED lights up orange and charging is started.
3. Charging time is different depending on the remaining power in the battery module. Typically charging is complete in 2 hours. When charging is complete, the CHARGE LED goes out and the FULL LED lights up green.

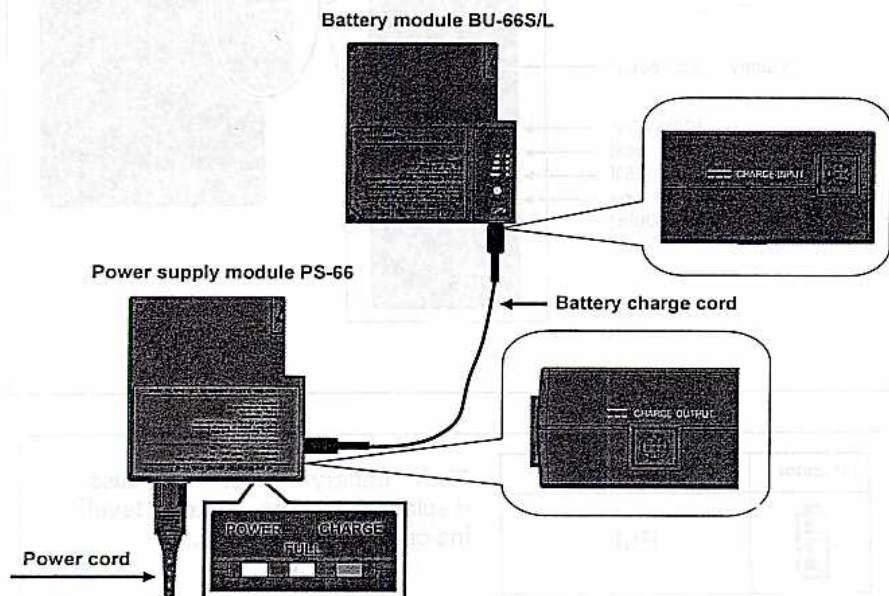

The battery module can be charged while installed in the splicer, but the power cannot be turned on.

When charging is complete, remove the battery module from the splicer and re-install it.

Charge the battery module within the following temperature range. Failure to do so may lead to deterioration in performance.

*Battery module's optimum temperature range: 0°C ~ 45°C

When the battery module is not used for an extended period, the capacity might be decreased. Charge and discharge the battery a few times.

DC operation

The special cord is required to operate the splicer on DC power such as vehicle adapter cable. Contact our sales personnel.

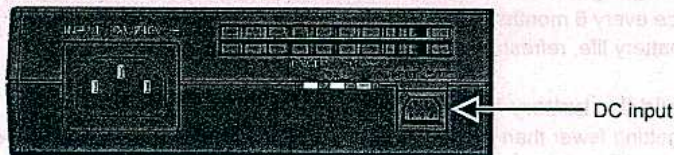

Battery refreshing

To extend battery life it is recommended that batteries be completely drained before re-charging. Otherwise the battery module loses its ability to fully recharge.

•Battery refreshing can be done in Maintenance menu.

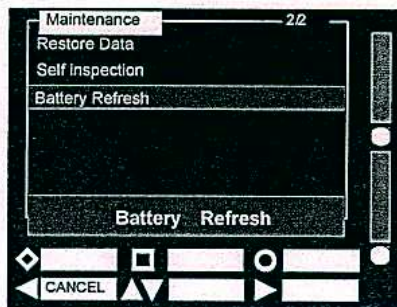

This screen is displayed if battery refreshing is selected. When refreshing is complete, the TYPE-39 is automatically turned off. Connect the PS-66 power supply module to the BU-66 battery module for charging.

Refresh time depends on the amount of charge remaining in the battery module. A fully charged battery module takes about 7.5 hours to refresh.

Precautions for battery module

- The battery module is a consumable. Repeated charging and discharging decreases battery life.
- Store the battery module within the following temperature range. Failure to do so may lead to deterioration in performance.
 - *Battery module storage temperature range:
 - 20°C ~ 50°C° (if storing for less than 3 months)
 - 20°C ~ 30°C° (if storing for less than 1 year)
- Do not use or store the battery module at high temperature, such as in strong direct sunlight, in cars during hot weather. This may cause leakage of battery fluid.

- Charge the battery module fully before storing it for a long period. The battery module will lose its charge during storage.
- Before using the battery module for the first time, charge the battery module.
- If you are not going to use the battery module for a long period, charge the battery module once every 6 months.
- To extend battery life, refresh the battery module once a month.

When should the battery be replaced?

If you are getting fewer than splice cycles per fully charged battery module, refresh the battery module. (See page 14.) If the splice cycles still do not increase after refreshing, consider replacing the battery.

When disposing of the battery, contact our maintenance service center or follow the local regulations.



Operating procedures

Turning on the TYPE-39

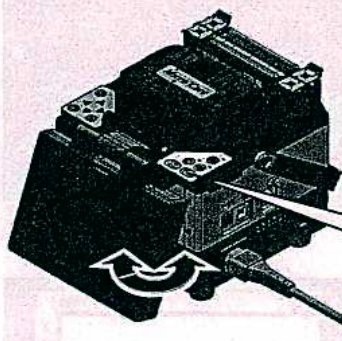

The monitor viewing angle can be adjusted.

- 1: Connect the AC power cord to the power supply module.
- 2: Adjust the monitor for optimum viewing angles.
- 3: Press the power () key for more than 1 second to turn on the power.



Special note on monitors

Although bright spots or dark spots may appear on the screen, this is a unique characteristic of liquid crystal displays, and such do not constitute or imply a machine defect.

Initial screen

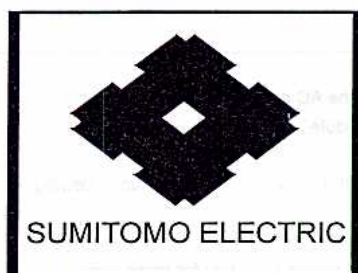

Startup screen

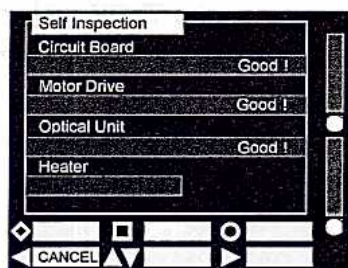

Self inspection screen

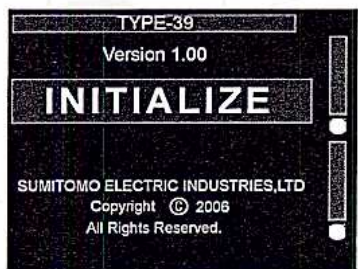

Self inspection is complete → Initializing screen

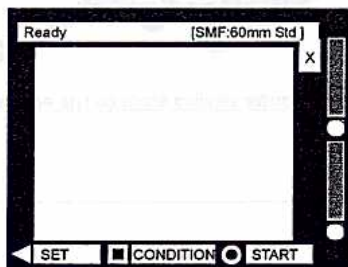

Initialization is complete → Ready screen

Fiber type and protection sleeve settings

Refer to page 38.

Stripping the fiber coating / Cleaning the bare

1: Strip the fiber coating with the JR-25.

Use the correct groove of the remover suitable for the fiber coating diameter.

→ See figure <1>.

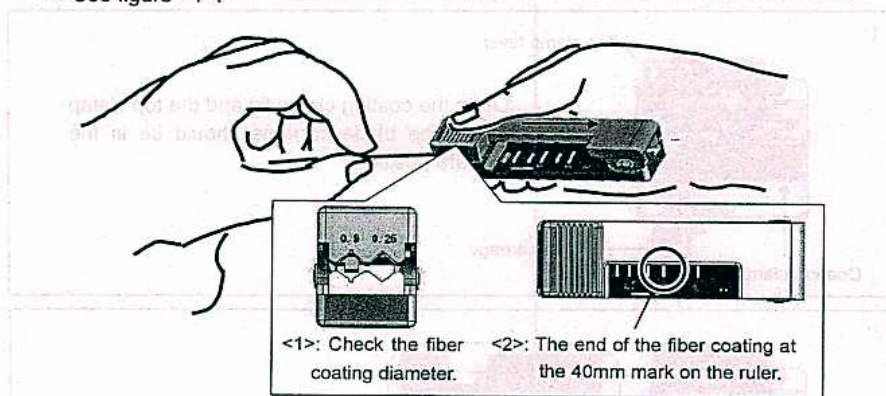

2: Position the end of the fiber coating at the 40mm mark on the ruler.

→ See figure <2>.

3: Strip 40mm of the fiber coating, referring to the figure below.

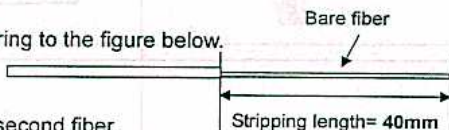

4: Repeat the stripping process for the second fiber.

5: Clean the bare fiber from the end of the fiber coating with a lint-free gauze pad moistened with pure alcohol. Pull the bare fiber through the gauze pad. Rotate the fiber by 90 degrees to remove any coating residue.

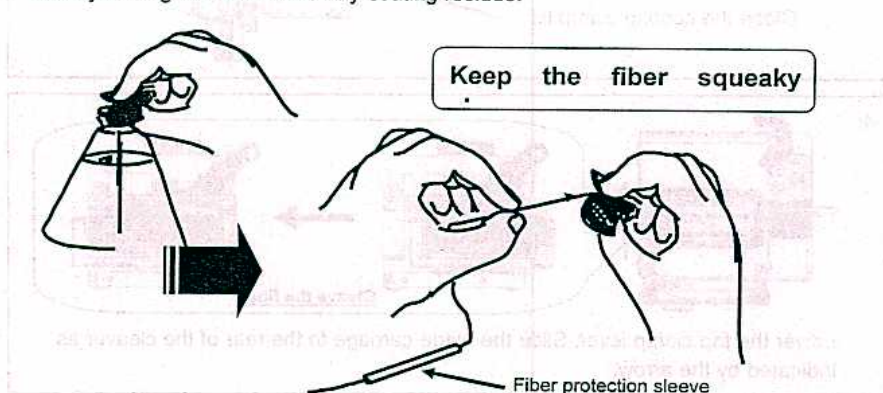

Cleaving the fiber

Cleaving the fiber with the FC-6S.

(Standard cleave length: 10mm Applicable cleave length: 8mm – 12mm)

1:

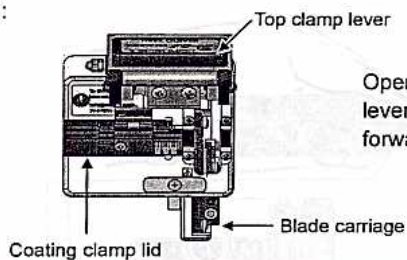

Open the coating clamp lid and the top clamp lever. The blade carriage should be in the forward position.

2:

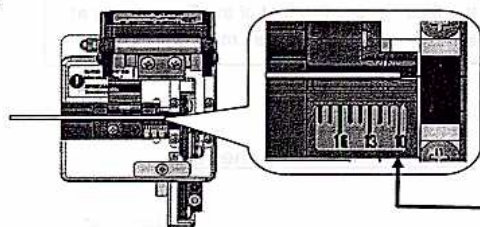

Lower the fiber into the correct V-groove with the end of the fiber coating at the 10mm mark on the ruler.

3:

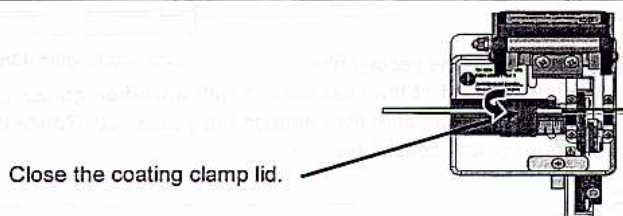

Close the coating clamp lid.

4:

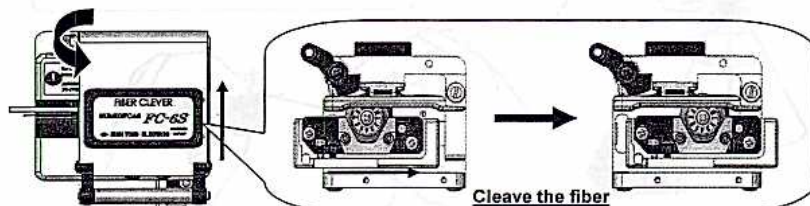

Lower the top clamp lever. Slide the blade carriage to the rear of the cleaver as indicated by the arrow.

5:

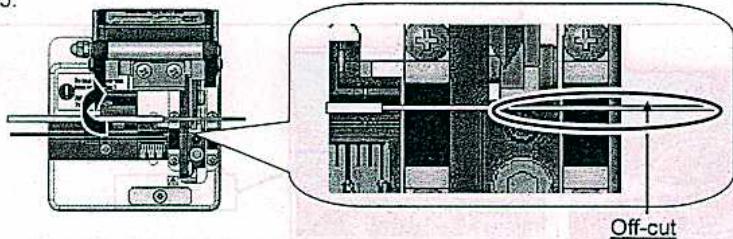

Open the top clamp lever.

Then open the coating clamp lid and lift the newly cleaved fiber.

Lift the off-cut and dispose of it properly.

6: Insert the fiber into the splicer.



1. Do not re-clean the fiber after cleaving.
2. To avoid damaging or contaminating the delicate fiber ends, insert each fiber immediately after preparation.
3. Glass-fiber fragments are extremely sharp. Handle with care.

Inserting fibers into the splicer

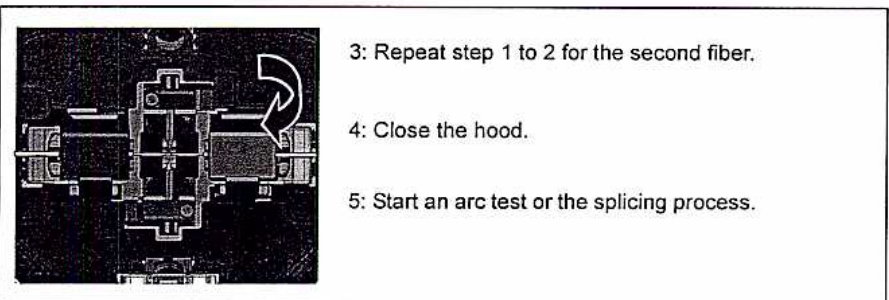
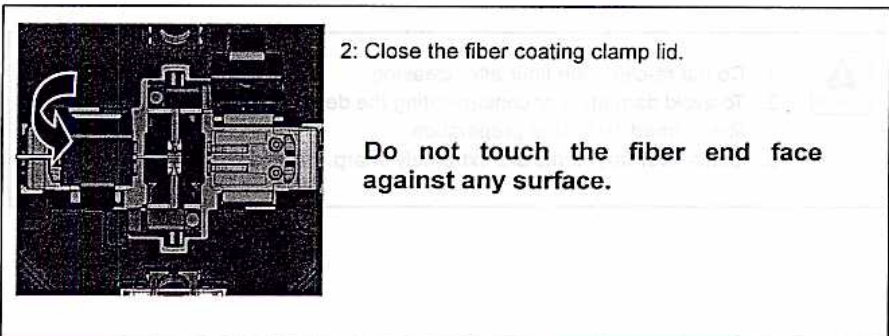
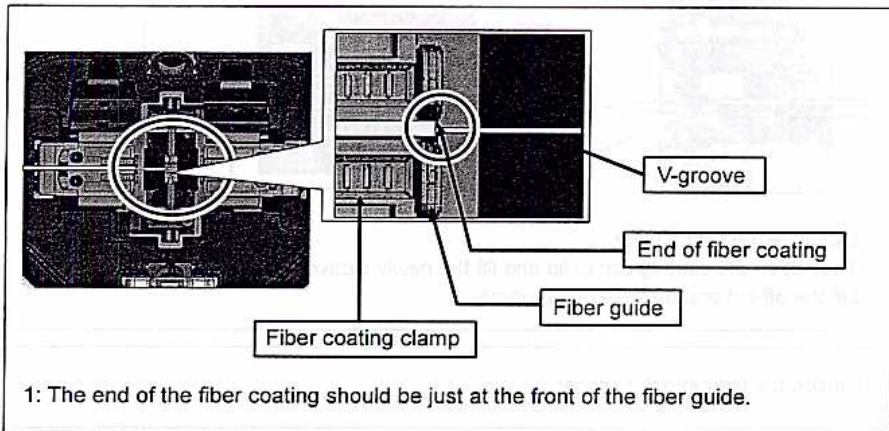

Arc test procedure

The fusion splicer has a built-in Arc test feature that should be used to ensure consistent high-quality splices. Performing an arc test automatically adjusts the arc power level for the splicing program selected.

Situations that should prompt an arc test are:

- Initial splicing set-up
- Changing fiber types
- Extreme changes in temperatures, humidity or air pressure
- Poor splice performance
- Worn or dirty electrodes and after electrode replacement

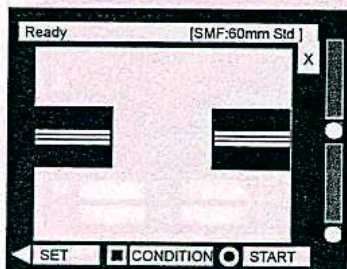

1: Strip the coatings, clean, cleave and insert the fibers. (Hereinafter called "prepare the fiber")

*Check to see if the selected splice program matches the fiber type to be spliced and the selected heating program matches the protection sleeve type to be shrunk on the screen after initialization.

2: Press the (CONDITION) key.

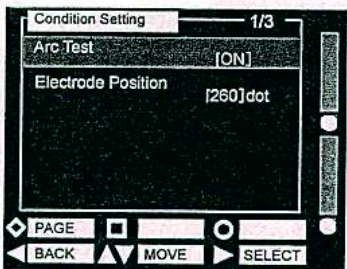

3: The screen shown in the left is displayed.

("Arc test" is selected.)

4: Press the (SELECT) key.

"OFF" is highlighted.

5: Press the or key to change to "ON".

6: Press the (SELECT) key.

Make sure that "ON" is displayed.

7: Press the (BACK) key.

"Arc Test Ready" screen will be displayed.

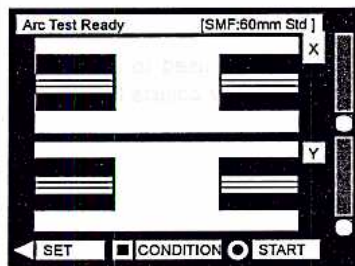

8: The screen shown in the left is displayed.
Ensure that "Arc Test Ready" is displayed at the upper left corner of the screen.

9: Press the (START) key.
The fibers are moved forward.

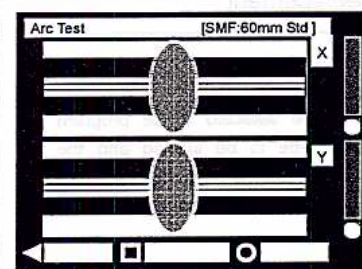

10: An arc test is started. (The fibers are not spliced.)

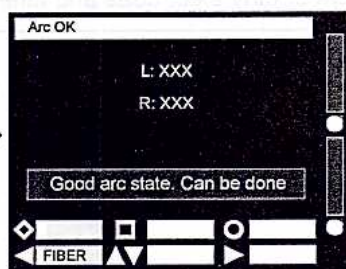

11: The amount of melt back is displayed.

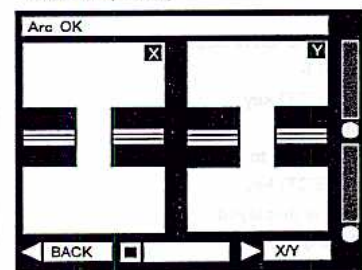

12: The arc test result is displayed.

Press the (FIBER) key. The arc test result with fiber images will be displayed.

13: If "ARC OK" is displayed, begin the fiber preparation procedure to perform a splice.

The splicer automatically initializes when the hood is opened.

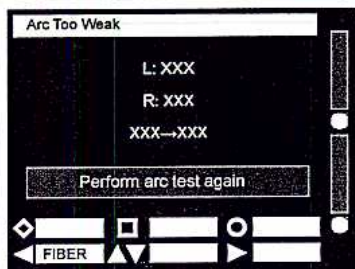

14: If "ARC TOO WEAK", "ARC TOO STRONG" or is displayed, prepare the fiber again and repeat the test until "ARC OK" is displayed.

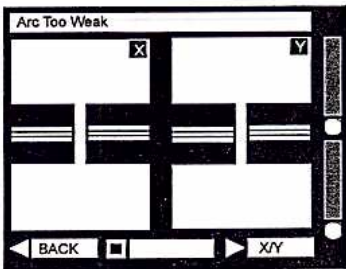

Arc test result

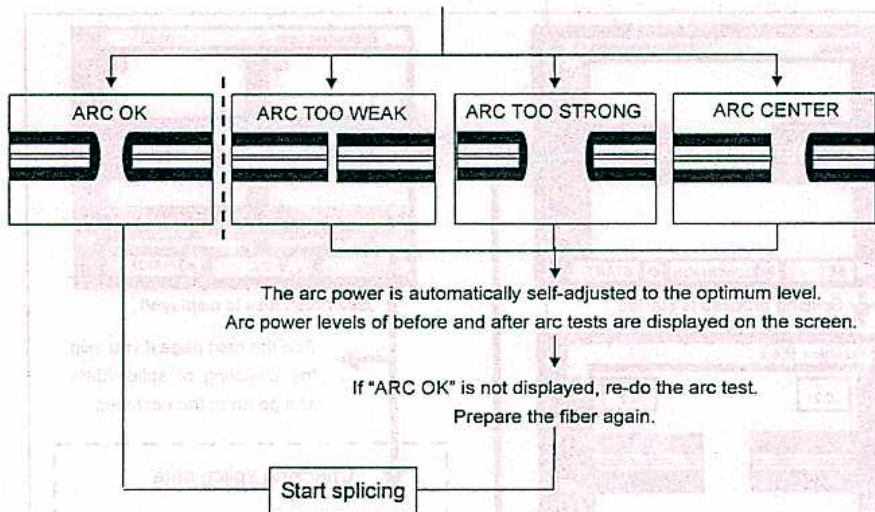

The adjusted arc power level is stored even if the splicer is turned off.

Fiber preparation

- 1: Be sure to slip the fiber protection sleeve over one of the fibers to be spliced before stripping and cleaving the fibers. The fiber protection sleeve cannot be installed after splicing.
- 2: Strip the fiber coating and clean the bare fiber.
Refer to page 18.
- 3: Cleave the bare fiber to proper cleave length.
Refer to page 19.
- 4: Insert the fiber into the splicer. Press the (SET) key to start the automatic splicing process.

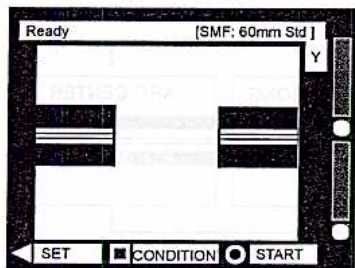

Splicing process is started

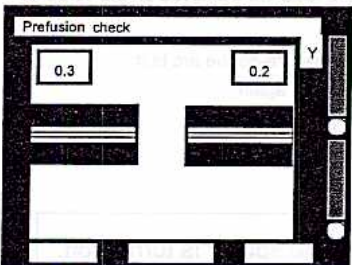

Inspection of fiber end face & dust

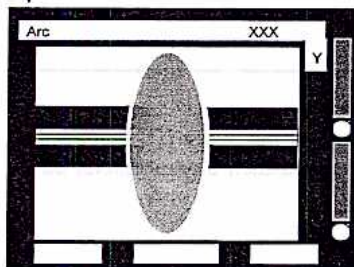

Arc is generated

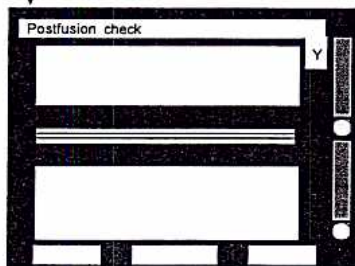

Fiber inspection after splice

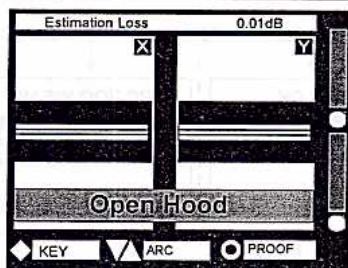

Estimated loss is displayed

See the next page if you skip the checking of splice data and go on to the next step.

Checking splice data

After a splice, press the (KEY) key. The screen shown below is displayed.

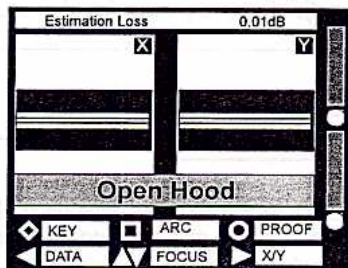

Press the (DATA) key. The screen shown below is displayed.

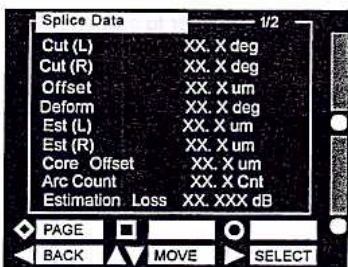

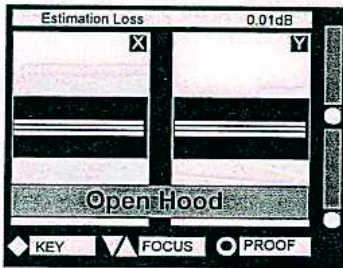

(if automatic proof test is selected)
Open the hood.

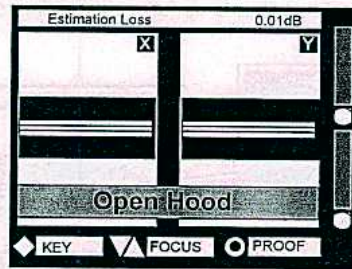

(if manual proof test is selected)
Press the (PROOF) key.

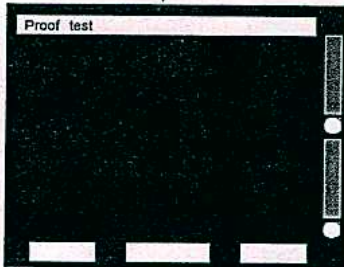

The proof test is automatically started.
1.96N (200gf)

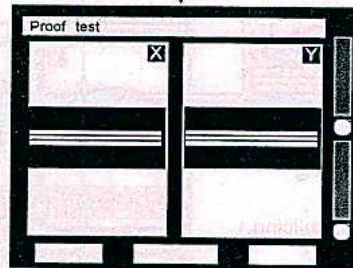

The proof test is started.
1.96N (200gf)

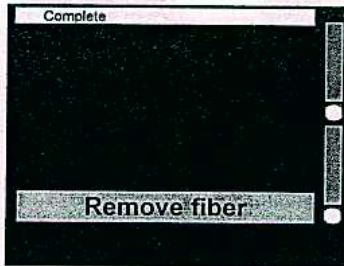

When the beep sounds, remove the fiber.

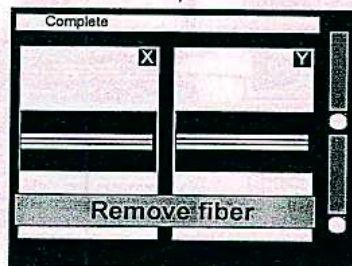

Open the hood and remove the fiber.

Take care to keep the spliced fiber straight. Do not flex it back and forth.

Evaluating splice quality

If the spliced fiber is as follows or estimated losses are high, re-do the entire splice.

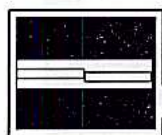

Kink or offset

(Re-do splicing.)

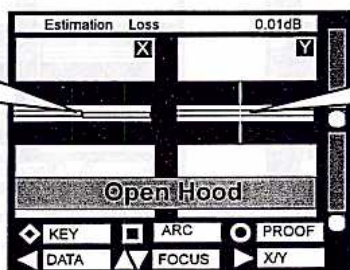

White line

(Re-arc→NG→
Re-do splicing)

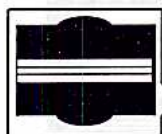

Bulging

(Re-do splicing.)

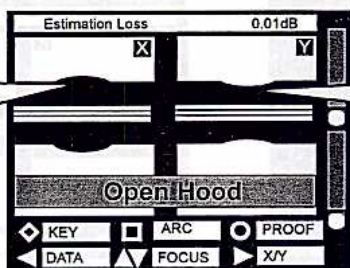

Neck-down

(Re-do splicing.)

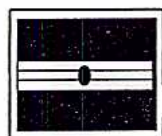

Bubble

(Re-do splicing.)

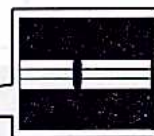
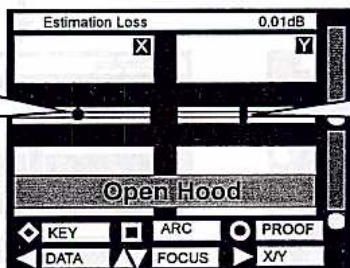

Black line

(Re-do splicing.)

Positioning the splice in the heat shrink oven

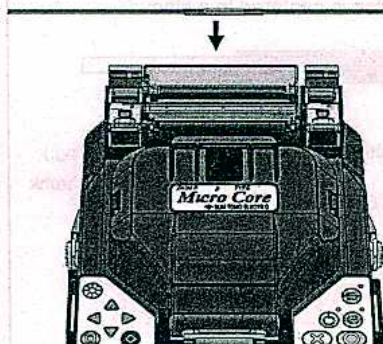

- 1: While maintaining a slight tension on the fiber end, lower the fiber onto the heat shrink oven and push down.

- Do not twist the fiber.
- Do not flex the fiber.

- 2: The 2 clamps and the transparent lid are closed.

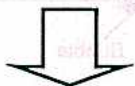

Make sure the fiber protection sleeve is centered inside the heat shrink oven.

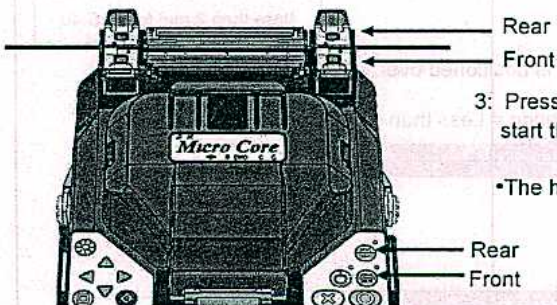

- 3: Press the (HEAT) key to start the shrinking process.

- The heat cycle is started.



Caution

After the heat cycle is complete, the fiber protection sleeve may be hot. Handle with care.

Never touch the surface of the heating plate during the heating operation. Doing so may cause personal injury and damage to the heat shrink oven.

Evaluating protection sleeve (with FPS-1)

OK

*at least 2 mm for FPS-40

- 1: Completely shrunk, no bubbles, the splice is centered in a sleeve



- 2: Flare in tubing (The shrinking sleeve is positioned over at least 6mm fiber coating.)

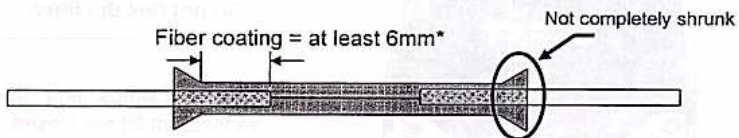

- 3: Bubbles on fiber coating

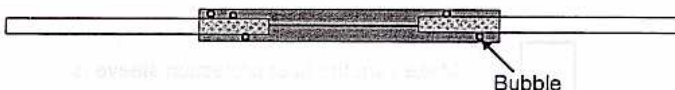

NG

*less than 2 mm for FPS-40

- 1: The shrinking sleeves is positioned over less than 6mm fiber coating

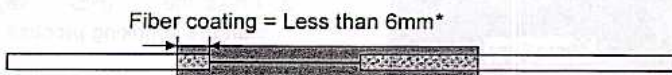

- 2: Bend in bare fiber



- 3: Bubbles on bare fiber



Maintenance

To keep excellent splice quality, regular cleaning and inspection are required. Especially cleaning should be performed before and after each use. We recommend your splicer to be checked through our maintenance service once a year.



Turn off the TYPE-39 before maintenance work.

Cleaning

Clean each part with a cotton swab. Please bear in mind that daily cleaning can maintain splicer performance.

Names of components

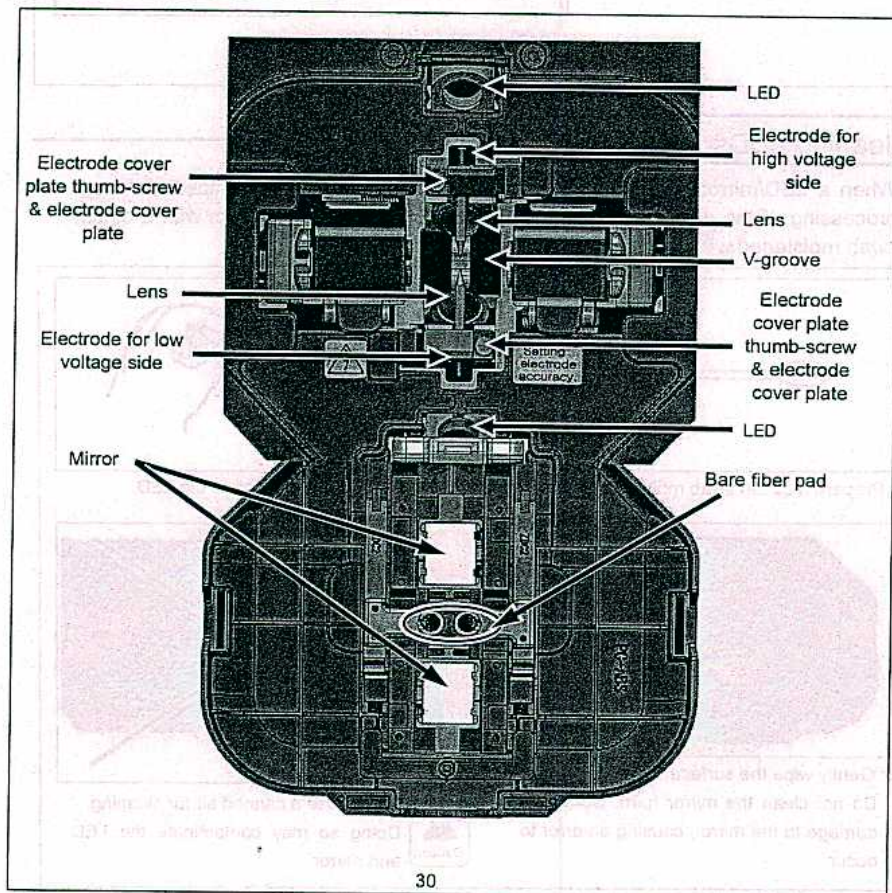

Cleaning V-grooves

Even tiny bits of dust or dirt in the V-grooves might cause the fiber to be offset. To avoid offset, carefully clean the V-grooves with a cotton swab moistened with alcohol.

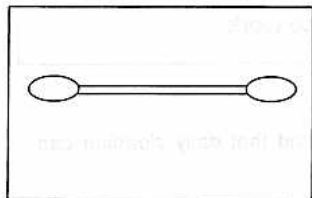

1: Prepare a cotton swab moistened with alcohol.

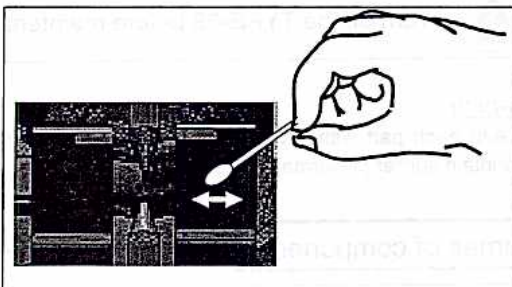

2: Brush the surface of the V-grooves.

Cleaning LEDs and mirrors

When a LED/mirror is dirty, a fiber image is unclear, resulting in imperfect image processing. If the display is uneven or LED error occurs, clean them with a cotton swab moistened with alcohol.

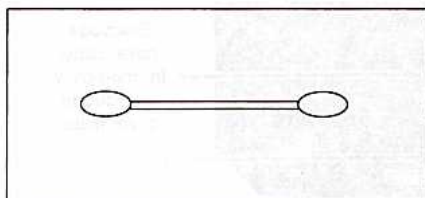

1: Prepare a cotton swab moistened with alcohol.

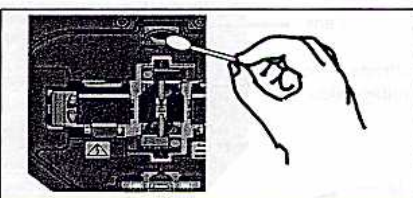

2: Gently wipe the surface of the LED.

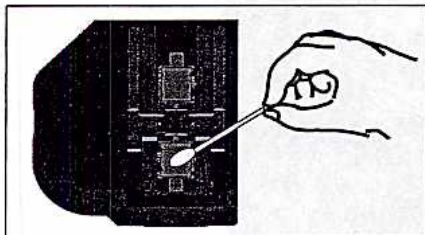

3: Gently wipe the surface of the mirror.

Do not clean the mirror hard. Doing will damage to the mirror, causing an error to occur.

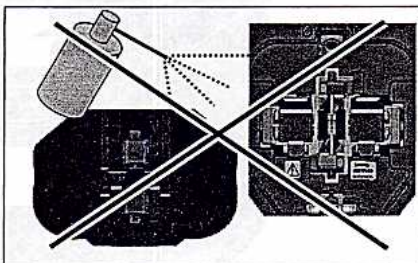

Do not use a canned air for cleaning. Doing so may contaminate the LED and mirror.

Cleaning bare fiber pads

Dirt on a bare fiber pad will also cause the fiber to be offset. When fiber offset occurs, clean the bare fiber pad.

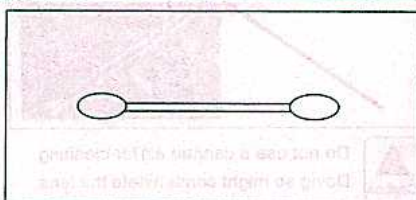

1: Prepare a cotton swab moistened with alcohol.

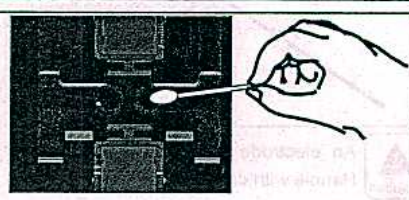

2: Clean the surface of the fiber clamps.

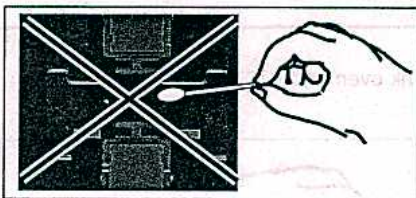

3: Do not apply too much force when cleaning.

Cleaning microscopes

If an unclear fiber image is still displayed or LED error occurs again after cleaning LEDs or mirrors, clean the microscopes.

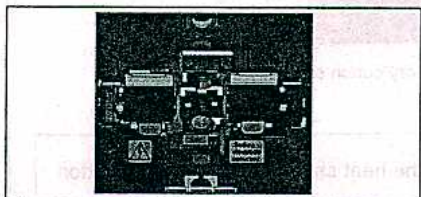

1: Remove the electrodes, referring to the "Replacing electrodes".

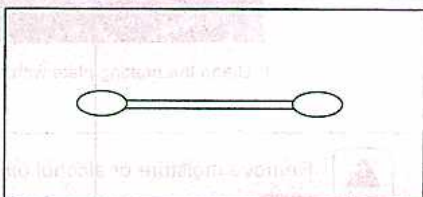

2: Prepare a cotton swab moistened with alcohol.

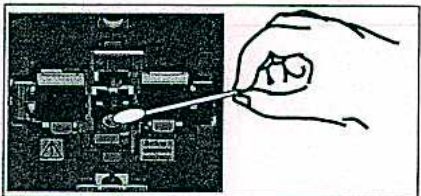

3: Gently wipe the lens of the microscope in a circular motion.

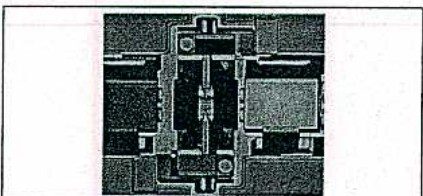

4: Re-fit the electrodes.

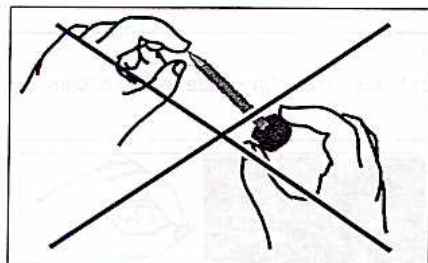

An electrode tip is extremely sharp.
Handle with care.

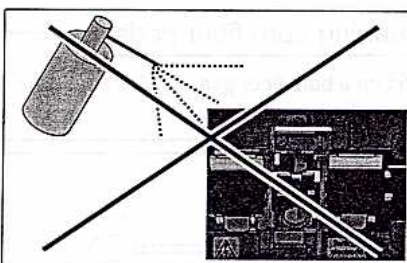

Do not use a canned air for cleaning.
Doing so might contaminate the lens.

Cleaning heat shrink oven

Dirt and dust can accumulate in the heat shrink oven easily. Clean the heating plate regularly with a dry cotton swab.

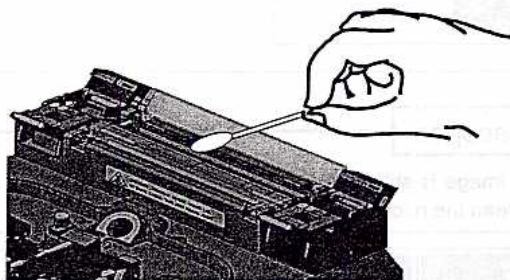

1: Clean the heating plate with a dry cotton swab.



Remove moisture or alcohol on the heat shrink oven with a dry cotton swab.

Replacing electrodes

The electrodes will typically need replacing after approximately 1,000 discharges. The electrode tip is extremely sharp. Handle with great care.

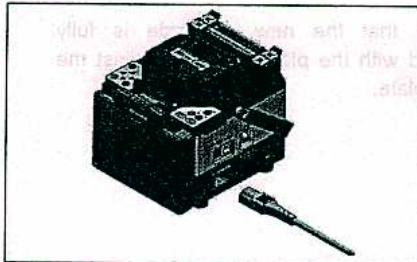

1: Turn off the splicer and unplug the power cord.

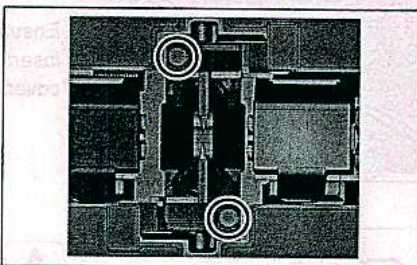

2: Using your fingers, loosen the thumbscrews to remove the electrode cover plates.

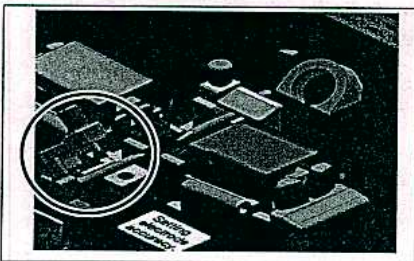

3: Lift the electrode cover plate as shown in the left figure.

4: Remove the old electrodes.

5: Install new electrodes.



When handling the electrodes, avoid touching the electrode tips with anything.

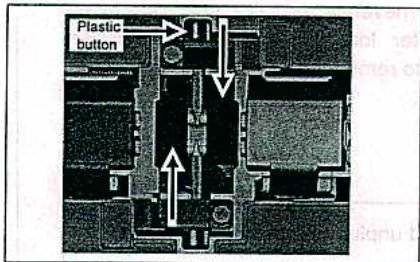

6: Tighten the thumbscrew while pushing the plastic button against the V-groove.

7: Repeat step 2 to 5 for the second electrode. Always replace both electrodes at a time.

8: Plug the power cord into the power module and turn on the power to condition the electrodes.

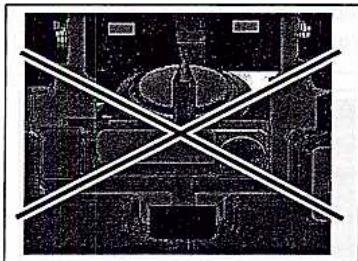

Ensure that the new electrode is fully inserted with the plastic button against the cover plate.

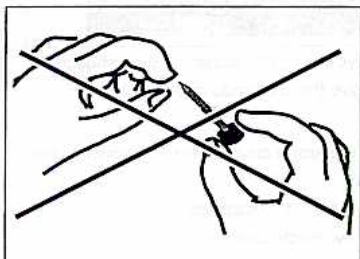

An electrode tip is extremely sharp. Handle with care.

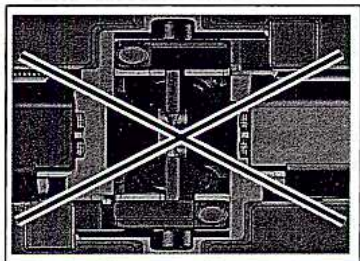

You can never remove the electrode cover plate after loosening the screw. Do not attempt to remove the electrode cover plate.



- Be sure to turn off the splicer and unplug the power cord before replacing the electrodes.
- Discard the old electrodes properly.

Packing and storage instructions

- Store the TYPE-39 and its accessories in a designated place in the case referring to the photo below.
- Store the splicer in the direction shown in the photo below.
- The splicer with a cooling tray cannot be stored in the case. Remove the cooling tray from the splicer and store it in the pocket.

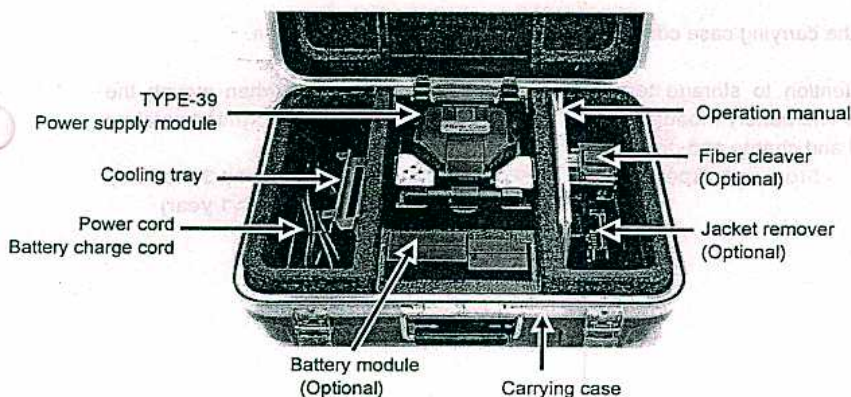

The TYPE-39 fusion splicer is a precision instrument. Its rugged shipping case is custom designed to protect it from impact, dust, dirt, and moisture. Always store and transport the machine in its case. Observe the following instructions.

- Clean the TYPE-39 and all accessories before storing them.
- Be sure to remove the battery from the TYPE-39 and store it in a given place.



Keeping the battery in the TYPE-39 may cause the battery terminal to be damaged or deteriorated, resulting in fire.

- Reposition the monitor before storing.
- Discard the liquid solvent properly, or lock the dispenser completely and put it in a plastic bag before packing the dispenser in the case.



Take extreme care of the handling of alcohol.

- Before storing the fiber cleaver, dispose of the fiber fragments collected in the off-cut collector in a proper way.



Glass fiber fragments are extremely sharp. Handle with care.

- Close the carrying case completely and latch it before transportation.
- Pay attention to storage temperature and dew condensation when storing the splicer. The battery module is self-discharged during storage. Perform temperature control and charge and discharge the battery once every 6 months.

Storage temperature -20°C ~ 50°C (if storing for less than 3 months)
-20°C ~ 30°C (if storing for less than 1 year)

3. Functions

Adjusting the settings

Fiber type and protection sleeve settings

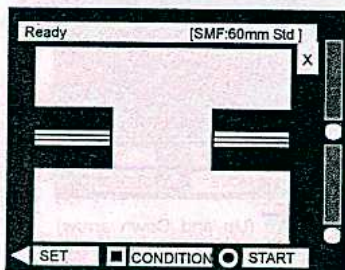

From the Ready screen, press the ◀ (SET) key to enter the MENU screen.

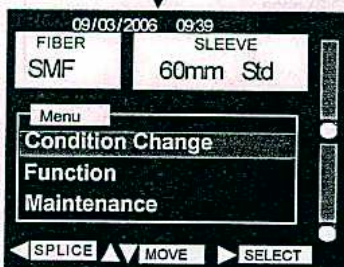

Press the ▶ (SELECT) key to enter the fiber selection screen.

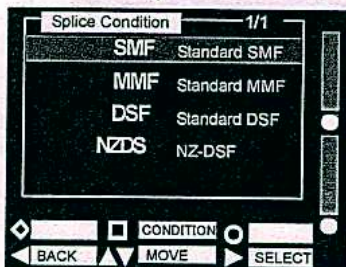

Press the ▶ (SELECT) key to enter the protection sleeve selection screen.

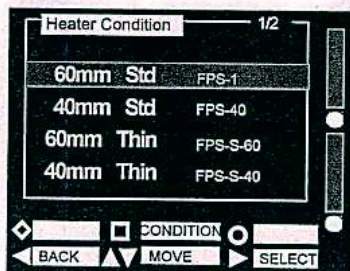

Press the ▶ (SELECT) key to go to the initial screen.

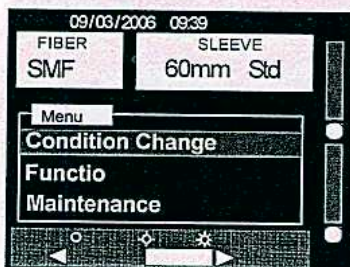

In this screen, monitor brightness can be adjusted if the (Brightness control) key is pressed.

Changing splice and heating conditions

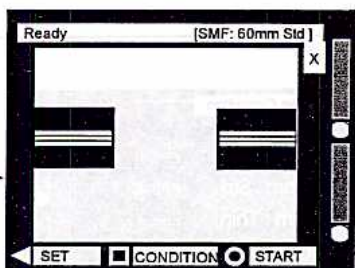

From the Ready screen, press the (CONDITION) key to enter the Condition Setting (1/3) screen.

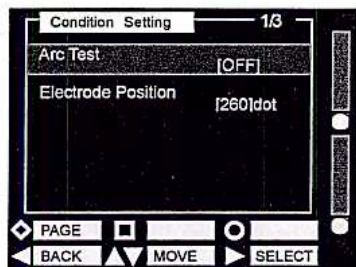

- 1: Use the ▲▼ (Up and Down arrow) keys to highlight the parameter you would like to change.
- 2: Use the ► (Right arrow) key to select the highlighted parameter.
- 3: Press the (PAGE) key to go to the next (2/3) page.

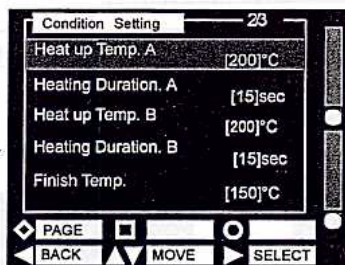

- 1: Use the ▲▼ (Up and Down arrow) keys to highlight the parameter you would like to change.
- 2: Use the ► (Right arrow) key to select the highlighted parameter.
- 3: Press the (PAGE) key to go to the next (3/3) page.

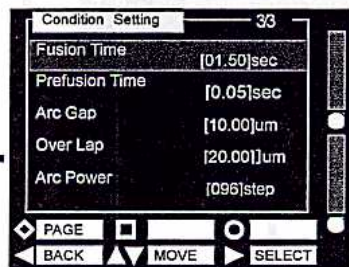

- 1: Use the ▲▼ (Up and Down arrow) keys to highlight the parameter you would like to change.
- 2: Use the ► (Right arrow) key to select the highlighted parameter.
- 3: Press the ◀ (BACK) key to go to the initial screen.

Splice condition settings	
Fusion Time (seconds)	Fusion time is the duration of arc discharge.
Prefusion Time (seconds)	Pre-fusion time is the time in seconds the fiber ends wait after the arc discharge begins before beginning the overlap (feed).
Arc Gap (micrometers, μm)	Arc gap is the distance between the left and right fibers before fusion takes place.
Over Lap (micrometers, μm)	Over lap is the amount of over lap between the left and right fibers that occurs when the right fiber is fed forward during the arc fusion.
Arc Power (Step value)	Expressed in a unitless step value, arc power controls the amount of heat the fibers are exposed to during the fusion arc.

Heating condition settings	
Heat Up Temperature A (degree)	Center area starts raising up to the set temperature.
Heating duration A (seconds)	After heat shrink oven reaches Heat Up Temperature, it maintains the temperature of center area for this duration.
Heat Up Temperature B (degree)	Both ends start raising up to the set temperature.
Heating duration B (seconds)	After heat shrink oven reaches Heat Up Temperature, it maintains the temperature of both ends for this duration.
Finish Temperature (degree)	This is the finish temperature to take out the sleeve. The flashing indication on the keypad stops at this temperature and a beep sounds.

Function settings

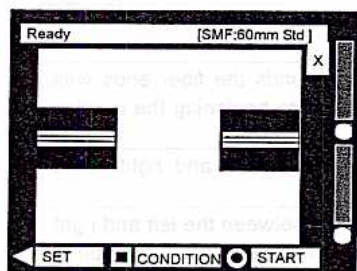

Press the **◀** (SET) key to enter the Menu screen.

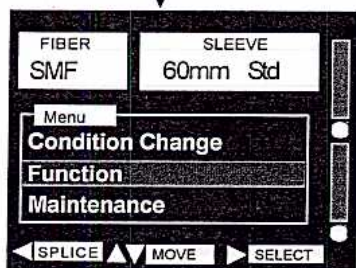

- 1: Use the **▲▼** (Up and Down arrow) keys to highlight the Function.
- 2: Press the **▶** (SELECT) key to enter the function settings (1/4) screen.

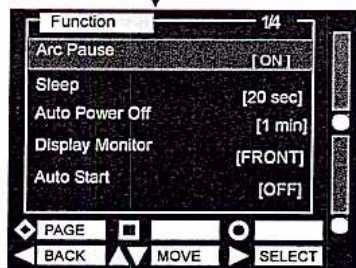

- 1: Use the **▲▼** (Up and Down arrow) keys to highlight the parameter you would like to change.
- 2: Press the **▶** (SELECT) key to change the settings.
- 3: Press the **◊** (PAGE) key to go to the next (2/4) page.

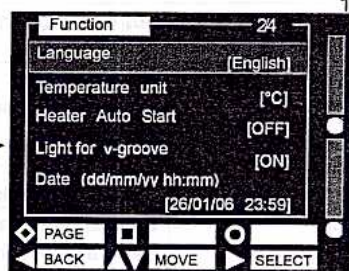

- 1: Use the **▲▼** (Up and Down arrow) keys to highlight the parameter you would like to change.
- 2: Press the **▶** (SELECT) key to change the settings.
- 3: Press the **◊** (PAGE) key to go to the next (3/4) page.

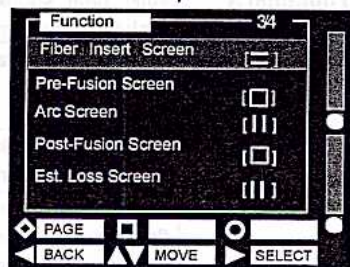

- 1: Use the **▲▼** (Up and Down arrow) keys to highlight the parameter you would like to change.
 - 2: Press the **▶** (SELECT) key to change the settings.
 - 3: Press the **◊** (PAGE) key to go to the next (4/4) page.
- See the next page regarding further screen indication.

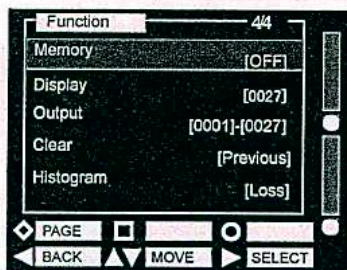

- 1: Use the \blacktriangle (Up and Down arrow) keys to highlight the parameter you would like to change.
- 2: Press the \blacktriangleright (SELECT) key to change the settings.

Regarding splice data storage function, see page 46.

Screen indication

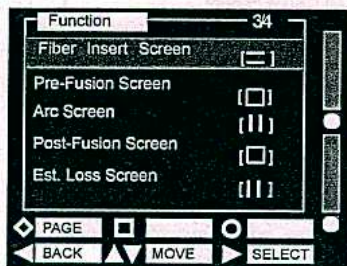

If [] is indicated on the screen, X or Y screen is displayed.

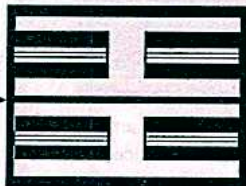

If [] is indicated on the screen, X and Y screens are vertically displayed.

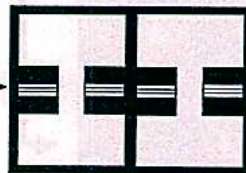

If [] is indicated on the screen, X and Y screens are horizontally displayed.

Maintenance settings

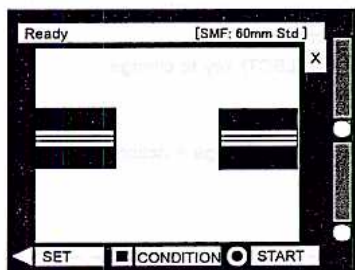

Press the ◀ (SET) key to enter the Menu screen.

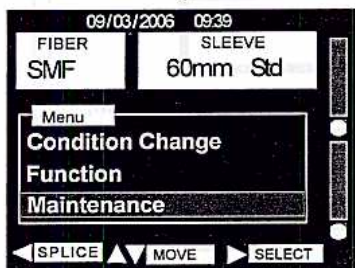

- 1: Use the ▲▼ (Up and Down arrow) keys to highlight the Maintenance.
- 2: Press the ▶ (SELECT) key to enter the maintenance settings (1/2) screen.

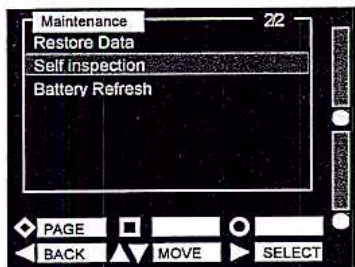

- Highlight and select "Self inspection" if you perform self inspection.

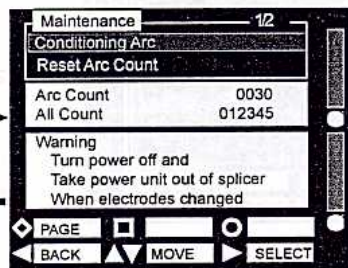

- 1: Use the ▲▼ (Up and Down arrow) keys to highlight the parameter you would like to change.
- 2: Press the ▶ (SELECT) key to change the settings.
- 3: Press the ◊ (PAGE) key to go to the next (2/2) page.

- 1: The Arc Count can be reset, while the All Count cannot.
- 2: After electrode replacement condition the electrodes.
- 3: Insert the electrode fully with the plastic button against the cover plate. Failure to do so will damage the machine.
- 4: Be sure to turn off the power and remove the power supply module before replacing the electrodes.

•Restore Data

All parameters except Arc Count and All Count are returned to the factory setting.

•Self Inspection

The circuit board, optical system, motors and heat shrink ovens are automatically inspected.

•Battery Refresh

Used to refresh the battery module.

4. Other functions

The TYPE-39 is provided with various functions. Set up the functions as necessary.

Back monitor type

The back monitor type is convenient when you would like to place the fiber to be spliced for installation closer to you.

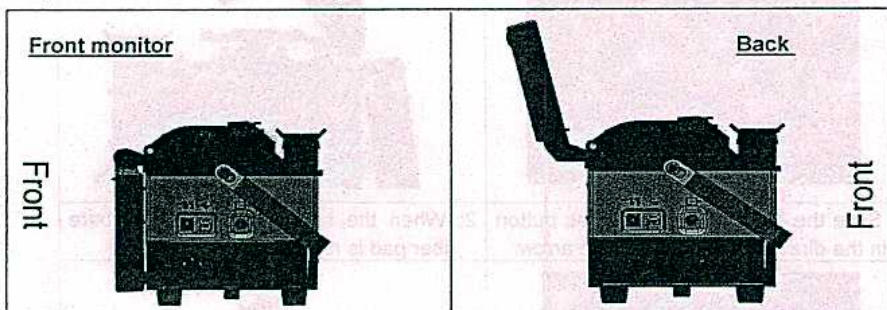

To set up the back monitor type
See page 41.

Dual heat shrink oven

2 heat shrink ovens are equipped with the TYPE-39. The ovens run individually and splicing operation can be improved more effectively. Both ovens also can be operated simultaneously.

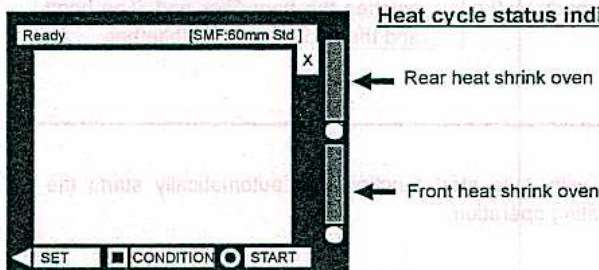

The heat cycle status indicator bar enables checking the progress of the heat cycle on the screen.

Detachable/attachable bare fiber pads

The bare fiber pad is moved in conjunction with the opening and closing of the hood. It can be separated from the hood to check to see if the fiber is clamped properly.

Detaching and attaching bare fiber pads

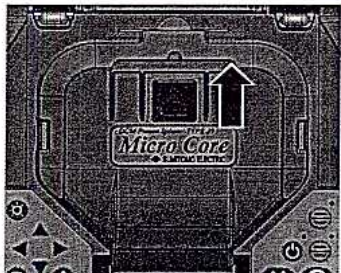

1: Slide the bare fiber pad release button in the direction indicated by the arrow.

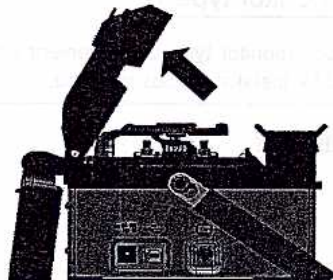

2: When the hood is opened, the bare fiber pad is removed from the hood.

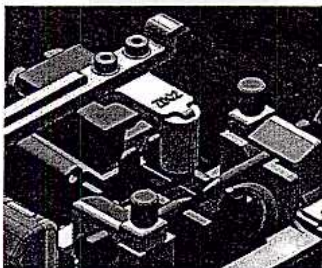

3: You can check if the fiber is placed seated in the V-groove properly by the pad.

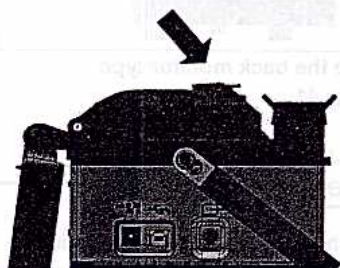

4: When the hood is closed, the hood catches the bare fiber pad. The hood and the pad are moved together.

Auto start

The TYPE-39 is provided with Auto start function that automatically starts the splicing process and the heating operation.

Auto start splicing

When the fiber is inserted into the splicer and the hood is closed, the splicing process is automatically started. The (SET) key does not need pressing.

To set up the auto start splicing

See page 41.

Auto start heating

When the fiber is placed into the heat shrink oven, the heating operation is automatically started. The (HEAT) key does not need pressing.

To set up the auto start heating

See page 41.

Splice data storage function

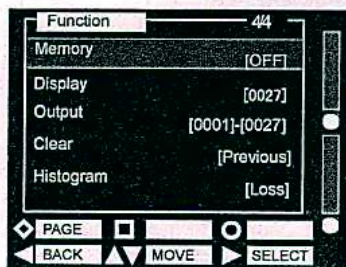

The TYPE-39 has the capability to record splice loss information for each splice that is performed.

•Memory

Splice loss data is stored automatically when splice is complete. A total of 2,000 splice data points can be stored. Set "Memory" to ON when you would like to store splice data.

•Display

Stored splice data is displayed. Enter the memory location you would like to view.

•Output

Stored splice data can be downloaded to a PC. Contact maintenance service center if you would like to use this function.

•Histogram

Stored splice data information is displayed under the histogram. Select the data you would like to view under the histogram.

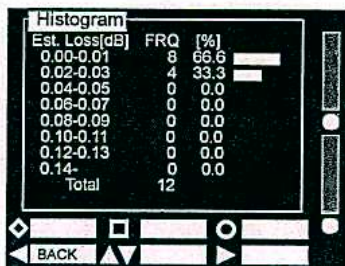
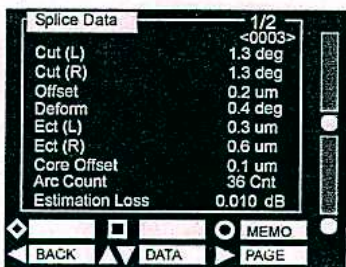

Tripod fixing screws

The TYPE-39 has screws for M8 screw and inch screw. In a high location, fix the splicer to a tripod to prevent it from dropping.

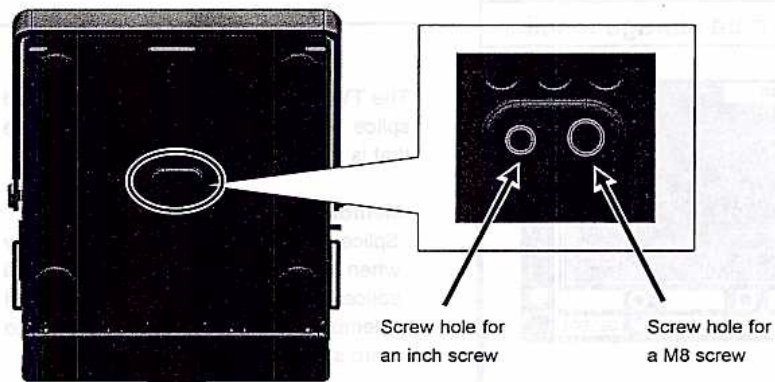

In a high location, fix the TYPE-39 to a tripod with the M8 screw or inch screw on the bottom of the splicer to prevent the splicer from dropping.

5. Troubleshooting

For repair and technical support, contact maintenance service center address described in the back cover.

Arc problems

The electrodes typically need replacement after **1000 splices**. Some common symptoms that indicate the electrodes need replacing are:

- Fluttering or unstable arc observed on the monitor
- Sizzling noise while arcing
- Bubbles in the fibers after splicing
- Fiber burned in half
- Diameter faults
- High or inconsistent splice losses

Refer to page 34, "Replacing electrodes" for procedures.

The tip will be deformed poor arcing problems can be caused. Take care of the handling of electrodes.

Fiber breaking

When the splicing process is complete, a proof test may be performed on the fibers while in the fiber chucks. If the fibers are breaking when the proof test is performed, re-do an arc test. If the arc power level is too weak, the splice may be poor, resulting in fiber breaking.

If the fibers are breaking in spite of a good arc test result, clean the V-grooves and the bare fiber pads completely. Deterioration of a jacket remover/fiber cleaver may lead to fiber breaking. Clean the jacket remover/fiber cleaver completely.

Splicer does not power up

If the fusion splicer fails to turn on when the ON key is pressed, check the following:

- Verify that the power supply module or battery module is installed in the module bay properly
- Verify that the power plug is seated properly (the power cord is connected to the power supply module.)
- Verify that the LED of the power supply module lights up.
- If using battery operation, ensure that the battery module is fully charged.

If the splicer still does not power up after checking the above, contact our maintenance service center.

Warranty and repair service

Before requesting a repair, try to locate the problem and identify the cause by referring to "5 Troubleshooting" at page 48. If you ensure that your machine is really in need of a repair, contact our maintenance service center.

Warranty period

1. We warrant that this product (TYPE-39 fusion splicer, installed software, and other equipment), in the course of its normal use, will be free from defect in materials and workmanship for one year (except consumables) from the date you acquire it.
2. The following cases are the exception for repairing and replacing the product free of charge.
 - (1) Damage or malfunction caused by misuse, mishandling, non qualified repair, disassembly, modification, or any other irregular execution
 - (2) Damage or malfunction caused by drop, fall or any other faulty treatment such as to be explained in precautions on this manual.
 - (3) Damage or malfunction caused by actions that are beyond Sumitomo's control including for example, fire, water flood, earthquake, lightening or similar disaster, or any other accident.
 - (4) Damage or malfunction caused by the use of Product in conjunction with accessories, products, or consumables not specified or approved by Sumitomo.
 - (5) Replacement of consumables
 - (6) Travel expense that is charged if a trip for repair is requested by the customer.
 - (7) Damage or malfunction caused by use of batteries and battery chargers not specified or approved by Sumitomo.
 - (8) Products founds corroded due to exposure to water or dew condensation, or cracked or deformed circuit board.
 - (9) The customer shall bear the cost of returning the product to Sumitomo. If the product becomes defective during the warranty period, Sumitomo shall bear the cost of returning the repaired product back.

Error message list

Please contact maintenance service center when it is not recovered if you take the measures below.

Error message	Causes and measures
Arc Test Error (Process Image)	<p>[Cause]</p> <ul style="list-style-type: none"> •The microscope lens, mirror or LED is contaminated. <p>[Measures]</p> <ul style="list-style-type: none"> •Clean the LED. •Clean the mirror inside the hood. •Clean the microscope lens. <p>Refer to "Maintenance" described in page 31-33 for the cleaning of LED, mirror, and microscope lens.</p> <ul style="list-style-type: none"> •Perform an arc test again.
Arc Too Strong Arc Too Weak	<p>[Causes]</p> <p>The amount of melt back is not optimum.</p> <p>[Measures]</p> <ul style="list-style-type: none"> •Perform an arc test again.
Brightness Error Brightness Various Error	<p>[Causes]</p> <ul style="list-style-type: none"> •The microscope lens, mirror or LED is contaminated. <p>[Measures]</p> <ul style="list-style-type: none"> •Clean the LED. •Clean the mirror inside the hood. •Clean the microscope lens. <p>Refer to "Maintenance" described in page 31-33 for the cleaning of LED, mirror, and microscope lens.</p>
Core Align Error IAS Align Error (Dust) (Timeout) (Process Image) (V-groove)	<p>[Causes]</p> <ul style="list-style-type: none"> •There is dust or dirt on the fiber. •The microscope lens, mirror or LED is contaminated. <p>[Measures]</p> <ul style="list-style-type: none"> •Prepare the fiber again. •Clean the LED. •Clean the mirror inside the hood. •Clean the microscope lens. <p>Refer to "Maintenance" described in page 31-33 for the cleaning of LED, mirror, and microscope lens.</p>

Error message	Causes and measures
Cut Error L / R / LR (Angle) (Crack) (Projection)	[Causes] •The fiber is not cleaved properly. [Measures] •Prepare the fiber again. •Clean the upper and lower bare fiber pads of the cleaver •The cleaver blade might be deteriorated. Change the blade position or replace the blade. For further information, refer to the operation manual of the cleaver.
Device Error	[Causes] • A system error has occurred. [Measures] •Turn off the power and turn it on. •If the error still persists, contact our maintenance service center.
Diameter Align Error (Dust) (Timeout) (Process Image) (V-groove)	[Causes] •There is dust or dirt on the fiber. •The microscope lens, mirror or LED is contaminated. [Measures] •Clean the LED. •Clean the mirror inside the hood. •Clean the microscope lens. Refer to "Maintenance" described in page 31-33 for the cleaning of LED, mirror, and microscope lens.
Estimation loss exceeds the limit. (The estimated loss is indicated in red.)	[Causes] •There is dust or dirt on the fiber. •Bubbles are generated in the splice. •The splice program or the splice condition is not optimum. [Measures] •Perform an arc test to obtain an optimum arc power level. •Ensure that the selected splice program is correct.
Fiber Detection Error	[Causes] •The fiber type does not match the selected splice program. [Measures] •To continue to the splicing process, press the Set key. •To cancel the splicing process, press the Reset key and change the fiber type or the splice program •If APDS is not necessary, change the settings.

Error message	Causes and measures
Fiber End Check Error	<p>[Causes]</p> <ul style="list-style-type: none"> •The microscope lens, mirror or LED is contaminated. <p>[Measures]</p> <ul style="list-style-type: none"> •Clean the LED. •Clean the mirror inside the hood. •Clean the microscope lens. <p>Refer to "Maintenance" described in page 31-33 for the cleaning of LED, mirror, and microscope lens.</p>
Focus Error (Process Image) (Microscope) (Dust/Diameter) (Timeout)	<p>[Causes]</p> <ul style="list-style-type: none"> •There is dust or dirt on the fiber. •The microscope lens, mirror or LED is contaminated. <p>[Measures]</p> <ul style="list-style-type: none"> •Prepare the fiber again.
Gap Adjust Error (Process Image) (Timeout)	<p>[Causes]</p> <ul style="list-style-type: none"> •The fiber end face is not clean. <p>[Measures]</p> <ul style="list-style-type: none"> •Prepare the fiber again. •Clean the upper and lower bare fiber pads of the cleaver •The cleaver blade might be deteriorated. Change the blade position or replace the blade. For further information, refer to the operation manual of the cleaver.
Hood Open Error	<p>[Causes]</p> <ul style="list-style-type: none"> •The hood is not closed completely. <p>[Measures]</p> <ul style="list-style-type: none"> •Close the hood completely.
Initialize Error	<p>[Causes]</p> <ul style="list-style-type: none"> •There is foreign material in the fiber stage. <p>[Measures]</p> <ul style="list-style-type: none"> •Check if there is any foreign material such as fiber coating residue around and in the fiber stage. •Turn off the power and turn it on again. Redo the splice.
Inserting Fiber Error	<p>[Causes]</p> <ul style="list-style-type: none"> •The fiber is not inserted into the splicer properly. <p>[Measures]</p> <ul style="list-style-type: none"> •Insert the fiber into the splicer properly. •Check if the cleave length is correct.

Error message	Causes and measures
Preadjust Error (Timeout) (V-groove) (Process Image)	<p>[Causes]</p> <ul style="list-style-type: none"> •The microscope lens, mirror or LED is contaminated. •There is dust or dirt in the V-groove. <p>[Measures]</p> <ul style="list-style-type: none"> •Clean the LED. •Clean the mirror inside the hood. •Clean the microscope lens. •Clean the V-groove. <p>Refer to "Maintenance" described in page 31-33 for the cleaning of LED, mirror, microscope lens and V-groove.</p> <ul style="list-style-type: none"> •Insert the fiber into the splicer properly and redo the splice.
Protusion Error	<p>[Causes]</p> <ul style="list-style-type: none"> •The fiber is inserted too much forward. <p>[Measures]</p> <ul style="list-style-type: none"> •Remove the fiber and press the Reset key. •Check if the cleave length is correct and insert the fiber into the splicer properly again.
Splice Error (Diameter/Core) (Process Image)	<p>[Causes]</p> <ul style="list-style-type: none"> •There is dust or dirt on the fiber. •Bubbles are generated in the splice. •The splice program or the splice condition is not optimum. <p>[Measures]</p> <ul style="list-style-type: none"> •Perform an arc test to obtain an optimum arc power level. •Ensure that the selected splice program is correct.

[Product specifications]

Optical fiber requirement	Material	Silica glass
	Profile type	SMF, MMF, DSF, NZ-DSF
	Fiber diameter	80 – 150 μ m
	Fiber coating diameter	100 – 1,000 μ m
	Cleave length	8 – 16mm (250 μ m coated fiber) 10mm (except for 250 μ m coated fiber)
	Fiber count	Single fiber
Size and weight	Size (main body) *1	150W × 150D × 150H
	Weight	Approx. 2.8 kg (with PS-66) Approx. 3.0 kg (with BU-66S)
	Monitor	5.6" TFT color monitor
Standard performance	Typical splice loss *2	SMF : 0.02dB
		MMF : 0.01dB
		DSF : 0.04B
		NZ-DSF : 0.04dB
	Typical splice cycle time *2	Approx. 12 seconds
	Typical heating cycle time *3	60mm sleeve Approx. 35 seconds
40mm sleeve Approx. 35 seconds		
Splicing/heating operation per fully charged battery *4	Approx. 100	
Functions	Loss Estimation	Provided
	Splice data storage	Provided
	Tension test *5	1.96N (200gf)
	Heat shrink oven	Provided
	Automatic arc test	Provided
	V-groove illumination	Provided
Programs	Splice programs	Max. 48
	Heating programs	Max. 20
Power supply	AC operation	With PS-66 Input AC 100 – 240V 50/60 Hz
	DC operation	With PS-66 and car battery cable Input: DC 10.5 – 15V 8A
	Battery operation	With BU-66S or BU-66L Nominal capacity BU-66S: 4500mAh BU-66L: 9000mAh Nominal voltage: 13.2V
	DC output	For heated jacket remover
Environmental conditions	Operation temperature *6	-10 °C ~ 50 °C
	Storage temperature *6 *7	-40 °C ~ 70 °C
	Altitude	0 to 3,660m
	Windproof	Max. 15m/s

*1 The protrusion part is not included.

*2 With Sumitomo identical fiber (in room temperature. Varies depending on the condition of fiber.)

*3 With the power supply module in room temperature (20°C). If the battery module is used, the heating cycle time varies depending on the temperature and the remaining battery capacity.

*4 With a new battery, 1 splice cycle time completes in 90 seconds, in room temperature.

- *5 Performed on the fiber stage after splicing.
- *6 Non-condensing
- *7 The Battery module storage temperature range: $-20^{\circ}\text{C} \sim 50^{\circ}\text{C}$ (if storing for less than 3 months)
 $-20^{\circ}\text{C} \sim 30^{\circ}\text{C}$ (if storing for less than 1 year)

Tokyo (Japan)
Sumitomo Electric Industries, Ltd.
(International Sales & Marketing Dept.)
3-12, Moto-Akasaka 1-chome, Minato-ku, Tokyo 107-8468 Japan
Tel: +81 (0)3 3423 5771/5689/5690
<http://www.sei.co.jp/SUMIOFCAS/english/index.html>

North Carolina (U.S.A.)
Sumitomo Electric Lightwave Corp.
78 Alexander Drive, P.O.Box 13445, Research Triangle park,
NC27709 U.S.A.
Tel: +1 919 541 8100
<http://www.sumitomoelectric.com>

London (U.K.)
Sumitomo Electric Europe Ltd.
220 Centennial Park, Centennial Avenue, Elstree, Herts, WD6 3SL, U.K.
Tel: +44 (0)20 8953 8118
<http://www.sumielectric.com>

Beijing (China)
Sumitomo Electric Industries, Ltd.
(Beijing Office)
Tel: +86 (0)10 8590 8192/8196

Shanghai (China)
Sumitomo Electric Industries, Ltd.
(Shanghai Office)
Tel: +86 (0)21 6278 5978

Hong Kong
Sumitomo Electric Asia, Ltd.
(Shanghai Office)
Tel: +852 2576 0080

Guangzhou (China)
Sumitomo Electric Asia, Ltd.
(Guangzhou office)
Tel: +86 (0)20 8666 5780

Bangkok (Thailand)
Sumitomo Electric (Thailand) Limited
Tel: +66 (0)2 260 7231 to 5

Singapore
Sumitomo Electric International
(Singapore) Pte Ltd.
Tel: +65 6261 3388

New Delhi (India)
Sumitomo Electric Industries, Ltd.
(New Delhi Office)
Tel: +91 (0)11 439 5115/5116

South Africa
Republic Power and Communication
Co.(Pty.) Ltd.
Tel: +27 (0)11 315 0334